



# Chapter 6: Entity-Relationship Model

**Database System Concepts, 5th Ed.**

©Silberschatz, Korth and Sudarshan  
See [www.db-book.com](http://www.db-book.com) for conditions on re-use





# Chapter 6: Entity-Relationship Model

- Design Process
- Modeling
- Constraints
- E-R Diagram
- Design Issues
- Weak Entity Sets
- Extended E-R Features
- Design of the Bank Database
- Reduction to Relation Schemas
- Database Design
- UML





# Modeling

- A *database* can be modeled as:
  - a collection of entities,
  - relationship among entities.
- An **entity** is an object that exists and is distinguishable from other objects.
  - Example: specific person, company, event, plant
- Entities have *attributes*
  - Example: people have *names* and *addresses*
- An **entity set** is a set of entities of the same type that share the same properties.
  - Example: set of all persons, companies, trees, holidays





# Entity Sets *customer* and *loan*

customer\_id   customer\_   customer\_   customer\_   loan\_   amount  
                  name        street        city                    number

321-12-3123	Jones	Main	Harrison
-------------	-------	------	----------

019-28-3746	Smith	North	Rye
-------------	-------	-------	-----

677-89-9011	Hayes	Main	Harrison
-------------	-------	------	----------

555-55-5555	Jackson	Dupont	Woodside
-------------	---------	--------	----------

244-66-8800	Curry	North	Rye
-------------	-------	-------	-----

963-96-3963	Williams	Nassau	Princeton
-------------	----------	--------	-----------

335-57-7991	Adams	Spring	Pittsfield
-------------	-------	--------	------------

*customer*

L-17	1000
------	------

L-23	2000
------	------

L-15	1500
------	------

L-14	1500
------	------

L-19	500
------	-----

L-11	900
------	-----

L-16	1300
------	------

*loan*





# Relationship Sets

- A **relationship** is an association among several entities

Example:

<u>Hayes</u>	<u>depositor</u>	<u>A-102</u>
<i>customer</i> entity	relationship set	<i>account</i> entity

- A **relationship set** is a mathematical relation among  $n \geq 2$  entities, each taken from entity sets

$$\{(e_1, e_2, \dots, e_n) \mid e_1 \in E_1, e_2 \in E_2, \dots, e_n \in E_n\}$$

where  $(e_1, e_2, \dots, e_n)$  is a relationship

- Example:

$(\text{Hayes}, \text{A-102}) \in \textit{depositor}$





# Relationship Set *borrower*

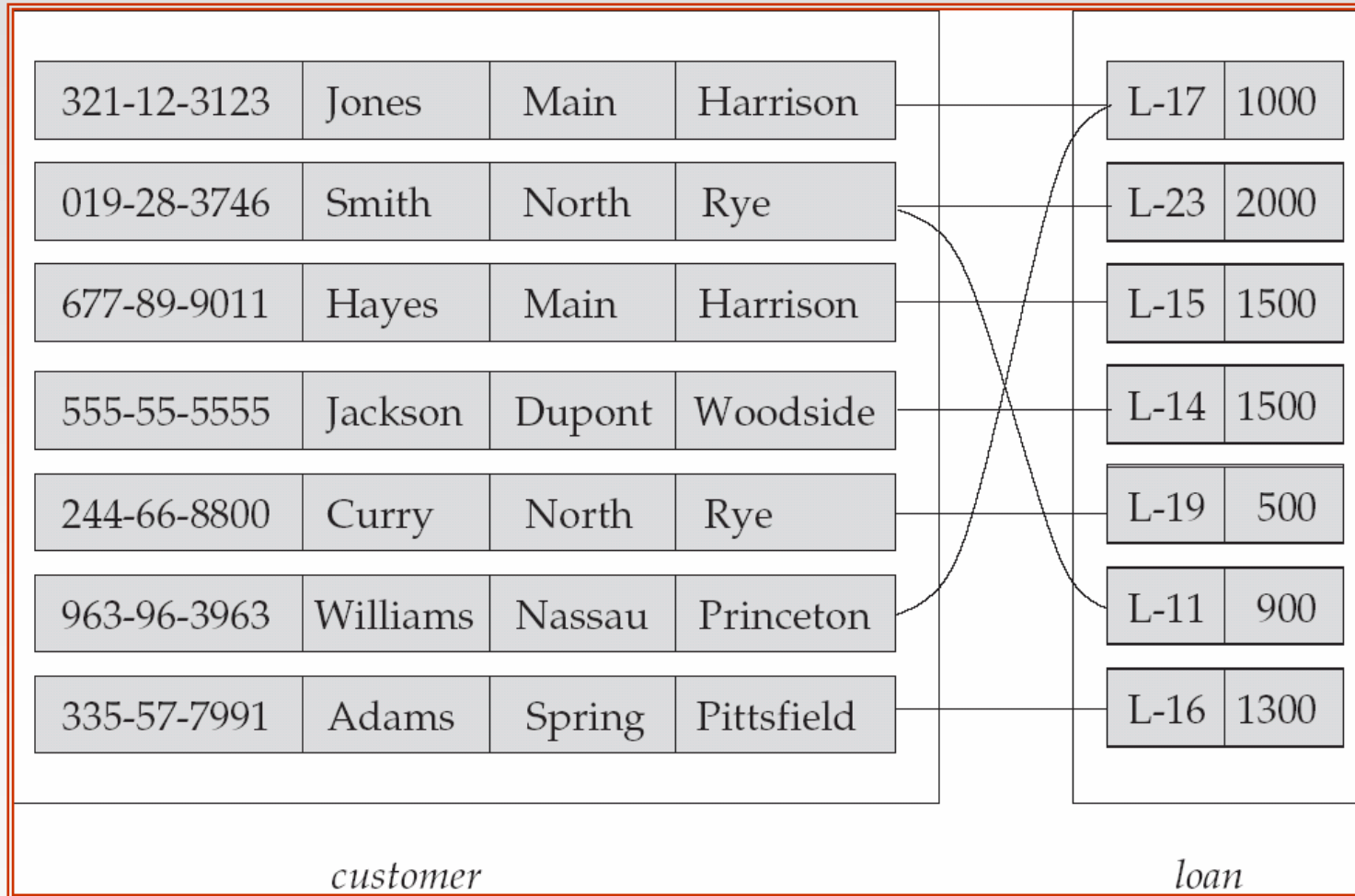



# Relationship Sets (Cont.)

- An **attribute** can also be property of a relationship set.
- For instance, the *depositor* relationship set between entity sets *customer* and *account* may have the attribute *access-date*

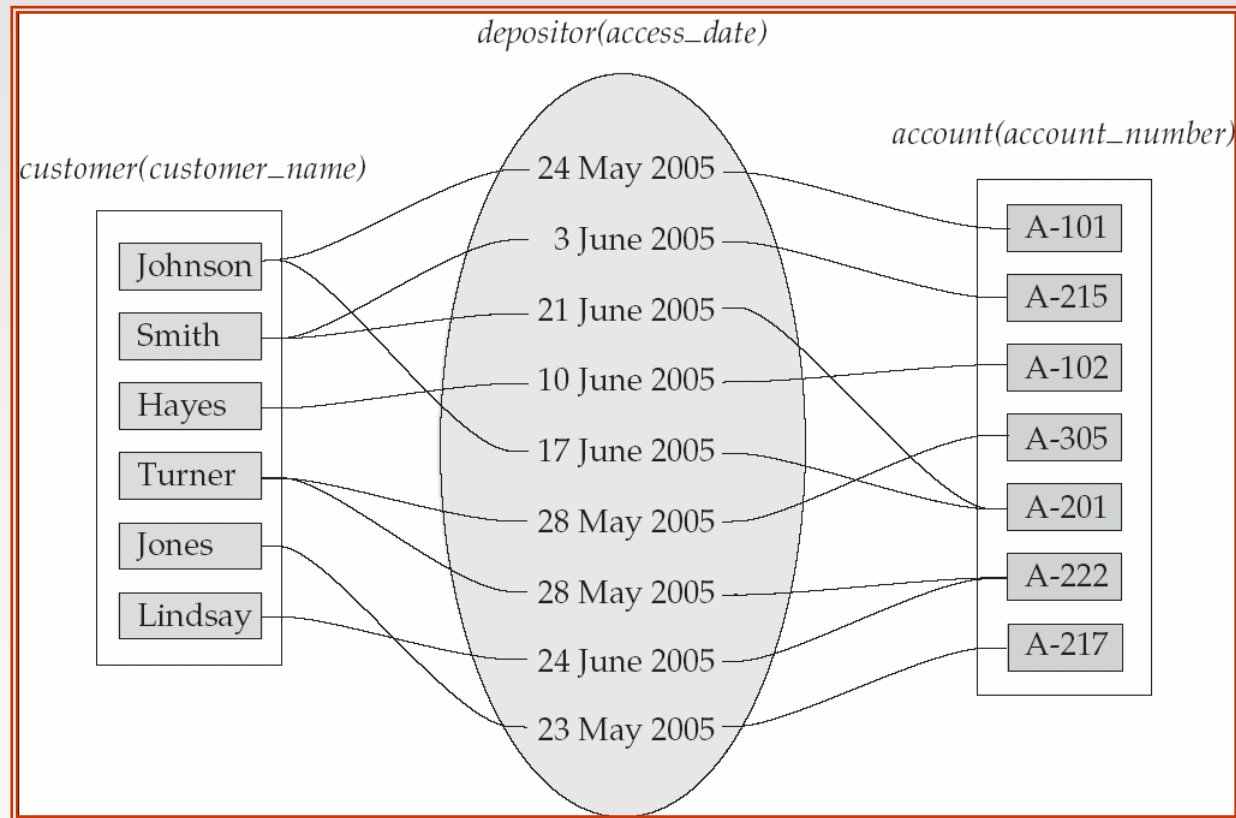



# Degree of a Relationship Set

- Refers to number of entity sets that participate in a relationship set.
- Relationship sets that involve two entity sets are **binary** (or degree two). Generally, most relationship sets in a database system are binary.
- Relationship sets may involve more than two entity sets.
  - ▶ Example: Suppose employees of a bank may have jobs (responsibilities) at multiple branches, with different jobs at different branches. Then there is a ternary relationship set between entity sets *employee*, *job*, and *branch*
- Relationships between more than two entity sets are rare. Most relationships are binary. (More on this later.)







# Attributes

- An entity is represented by a set of attributes, that is descriptive properties possessed by all members of an entity set.

Example:

*customer = (customer\_id, customer\_name,  
customer\_street, customer\_city )*  
*loan = (loan\_number, amount )*

- **Domain** – the set of permitted values for each attribute
- Attribute types:
  - *Simple and composite* attributes.
  - *Single-valued and multi-valued* attributes
    - ▶ Example: multivalued attribute: *phone\_numbers*
  - *Derived* attributes
    - ▶ Can be computed from other attributes
    - ▶ Example: age, given *date\_of\_birth*





# Composite Attributes

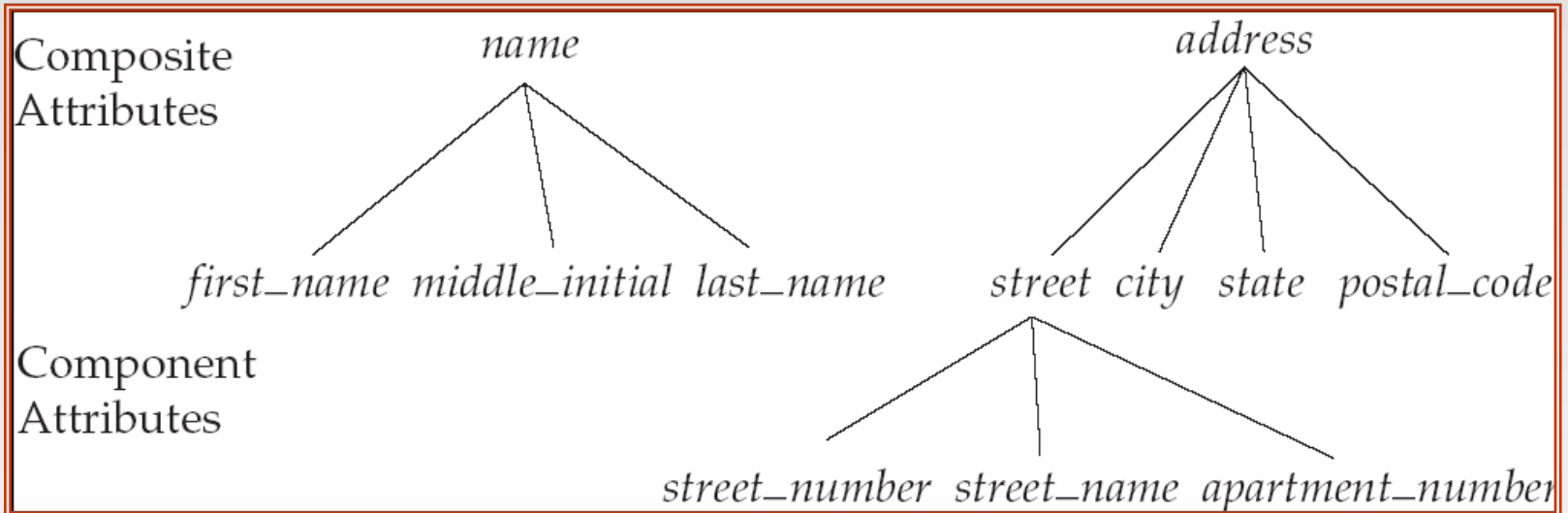



# Mapping Cardinality Constraints

- Express the number of entities to which another entity can be associated via a relationship set.
- Most useful in describing binary relationship sets.
- For a binary relationship set the mapping cardinality must be one of the following types:
  - One to one
  - One to many
  - Many to one
  - Many to many





# Mapping Cardinalities

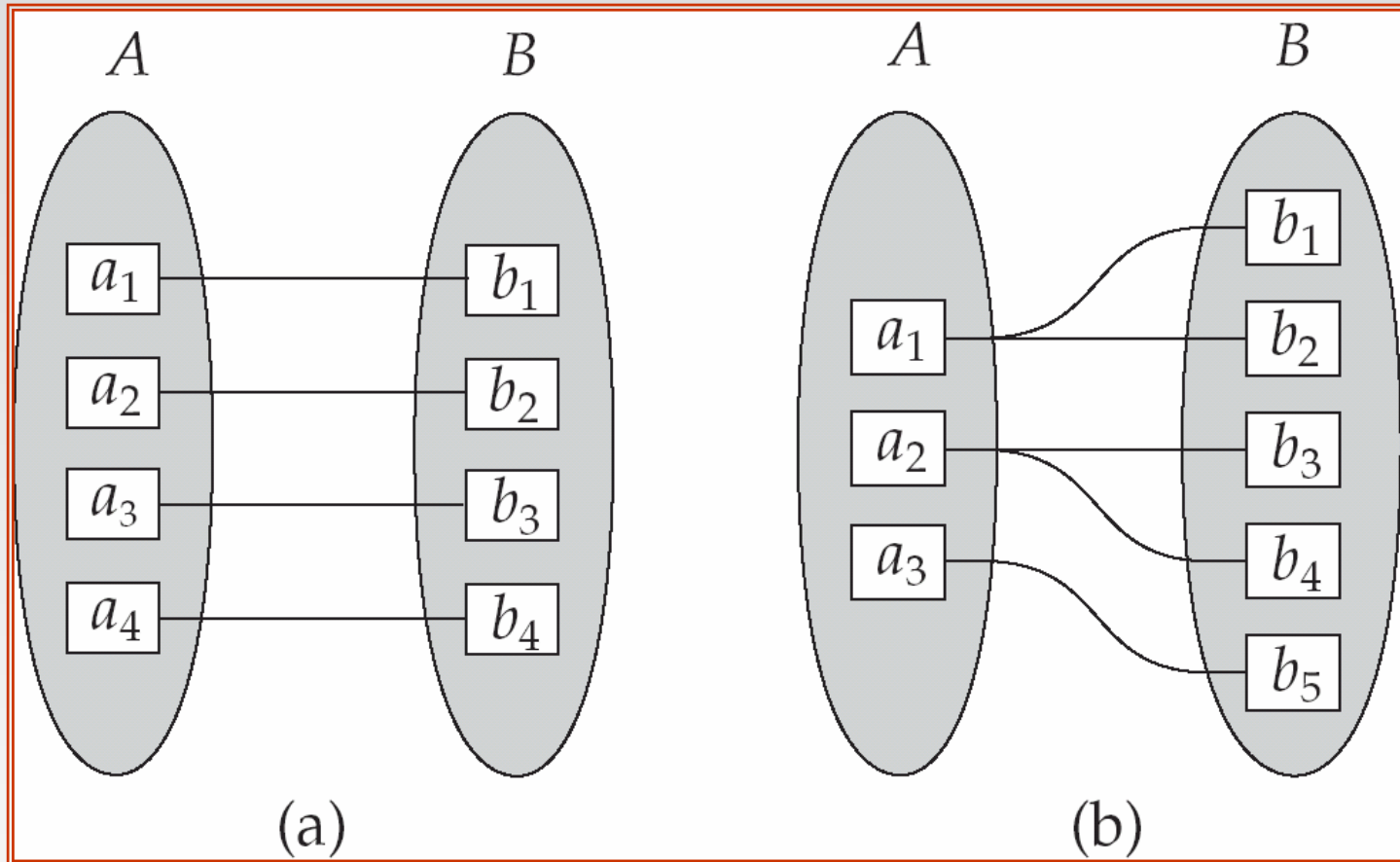

One to one

One to many

Note: Some elements in  $A$  and  $B$  may not be mapped to any elements in the other set





# Mapping Cardinalities

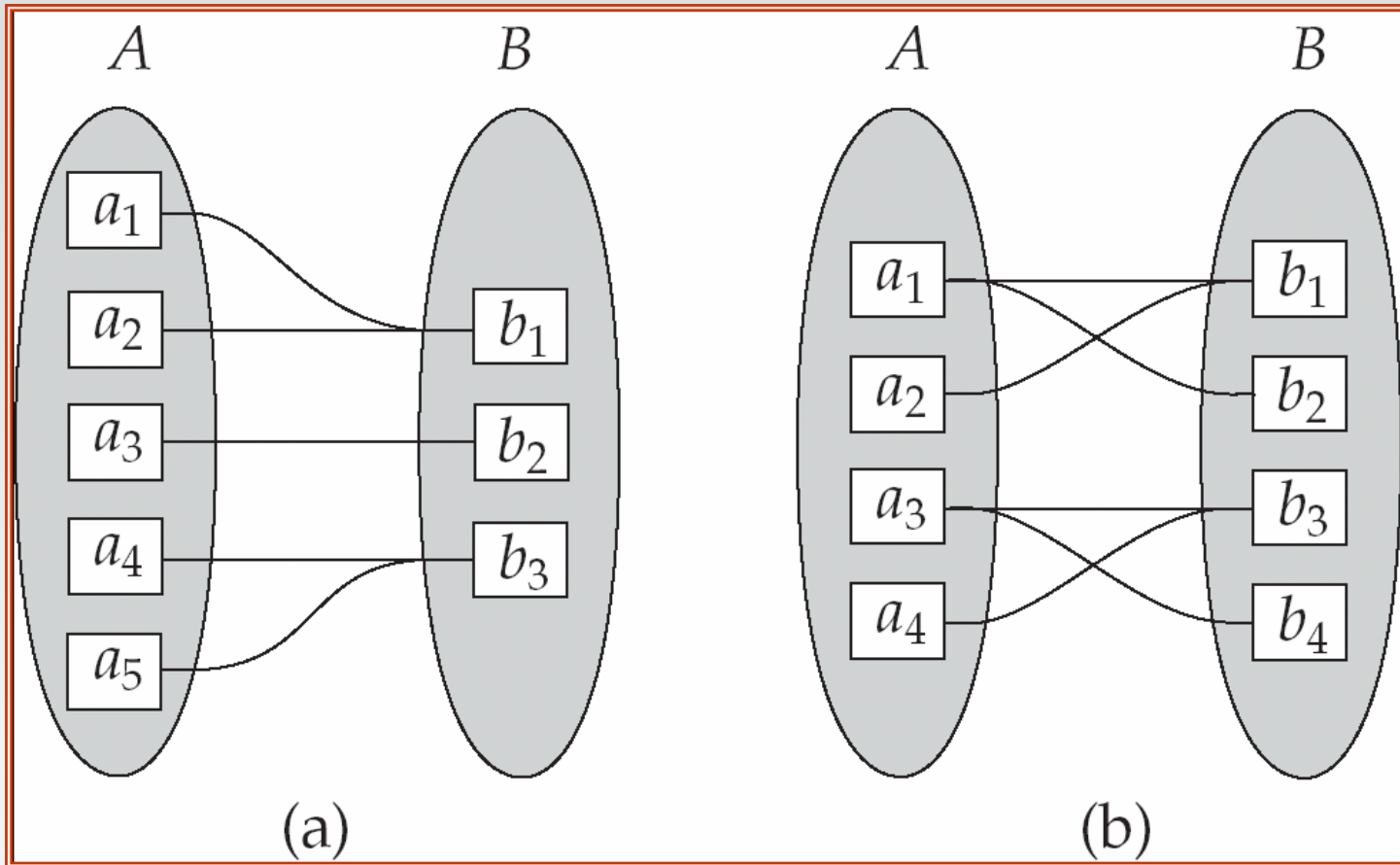

Many to one

Many to many

Note: Some elements in A and B may not be mapped to any elements in the other set





# Keys

- A **super key** of an entity set is a set of one or more attributes whose values uniquely determine each entity.
- A **candidate key** of an entity set is a minimal super key
  - *Customer\_id* is candidate key of *customer*
  - *account\_number* is candidate key of *account*
- Although several candidate keys may exist, one of the candidate keys is selected to be the **primary key**.





# Keys for Relationship Sets

- The combination of primary keys of the participating entity sets forms a super key of a relationship set.
  - *(customer\_id, account\_number)* is the super key of *depositor*
  - *NOTE: this means a pair of entity sets can have at most one relationship in a particular relationship set.*
    - ▶ Example: if we wish to track all *access\_dates* to each account by each customer, we cannot assume a relationship for each access. We can use a multivalued attribute though
- Must consider the mapping cardinality of the relationship set when deciding what are the candidate keys
- Need to consider semantics of relationship set in selecting the *primary key* in case of more than one candidate key





# E-R Diagrams

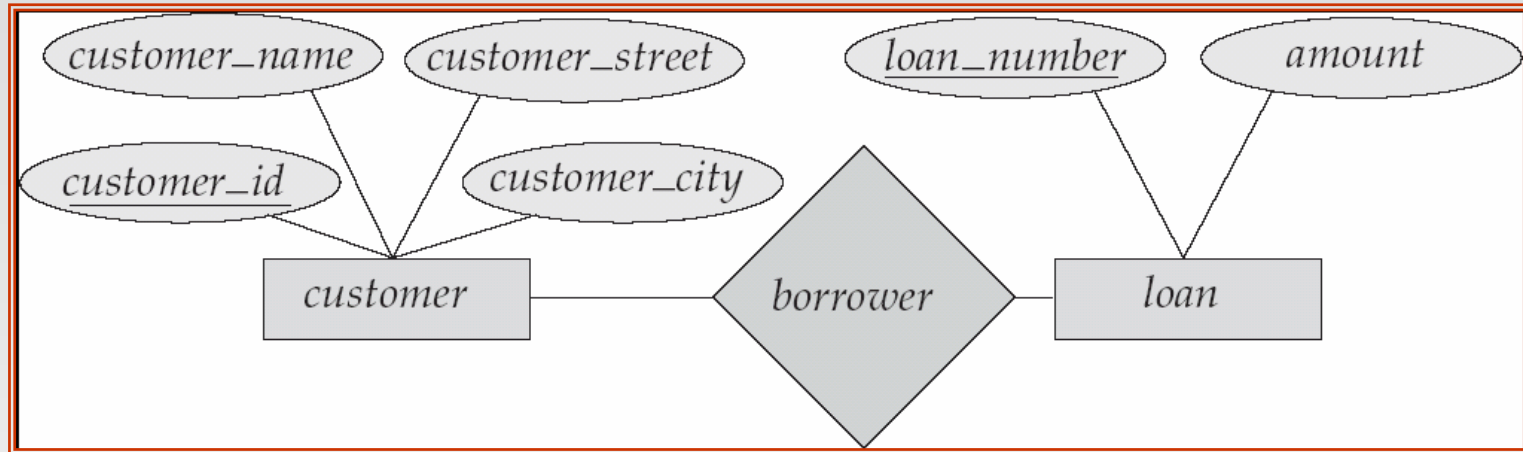

- Rectangles represent entity sets.
- Diamonds represent relationship sets.
- Lines link attributes to entity sets and entity sets to relationship sets.
- Ellipses represent attributes
  - Double ellipses represent multivalued attributes.
  - Dashed ellipses denote derived attributes.
- Underline indicates primary key attributes (will study later)







# E-R Diagram With Composite, Multivalued, and Derived Attributes

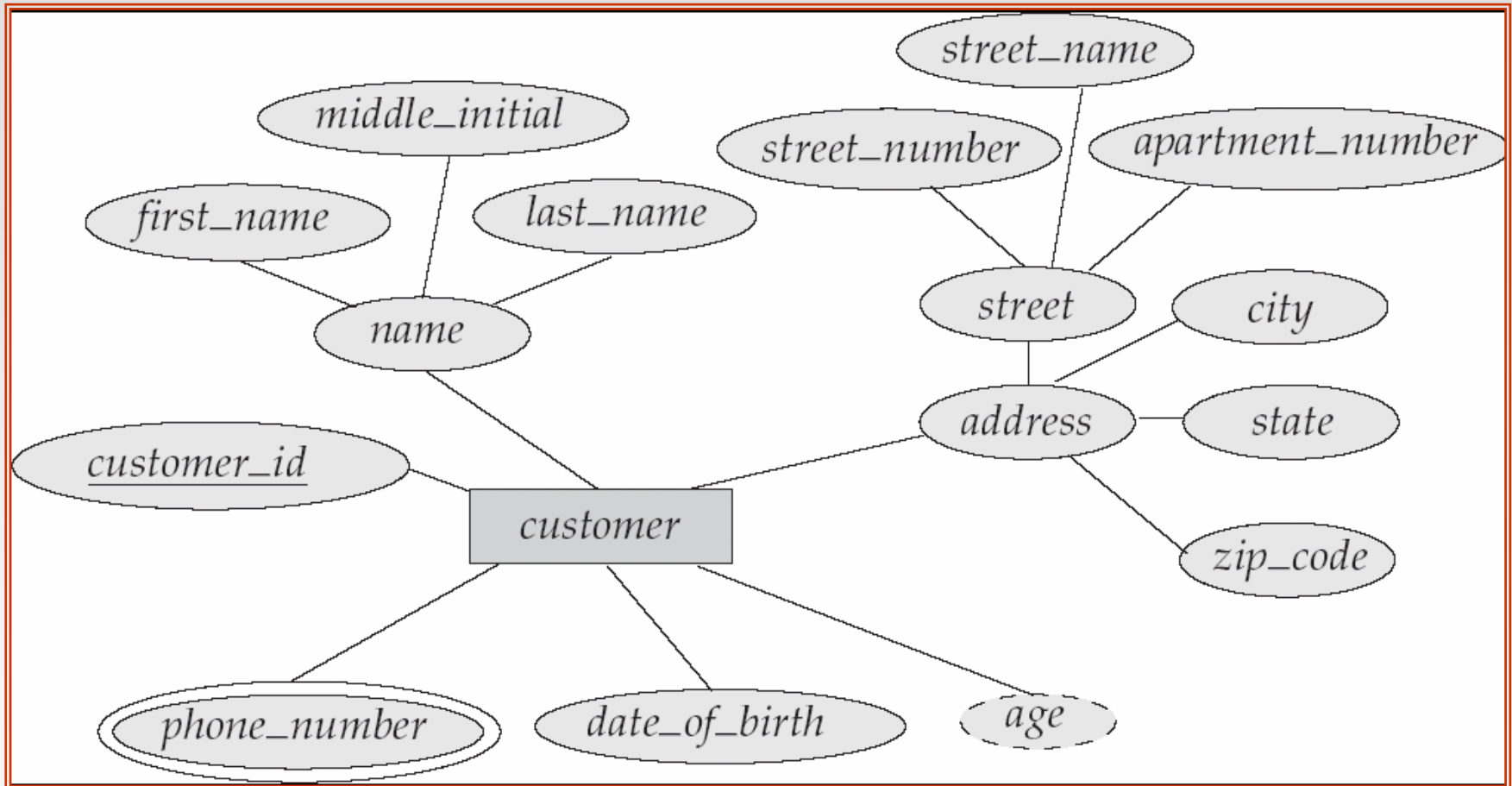



# Relationship Sets with Attributes

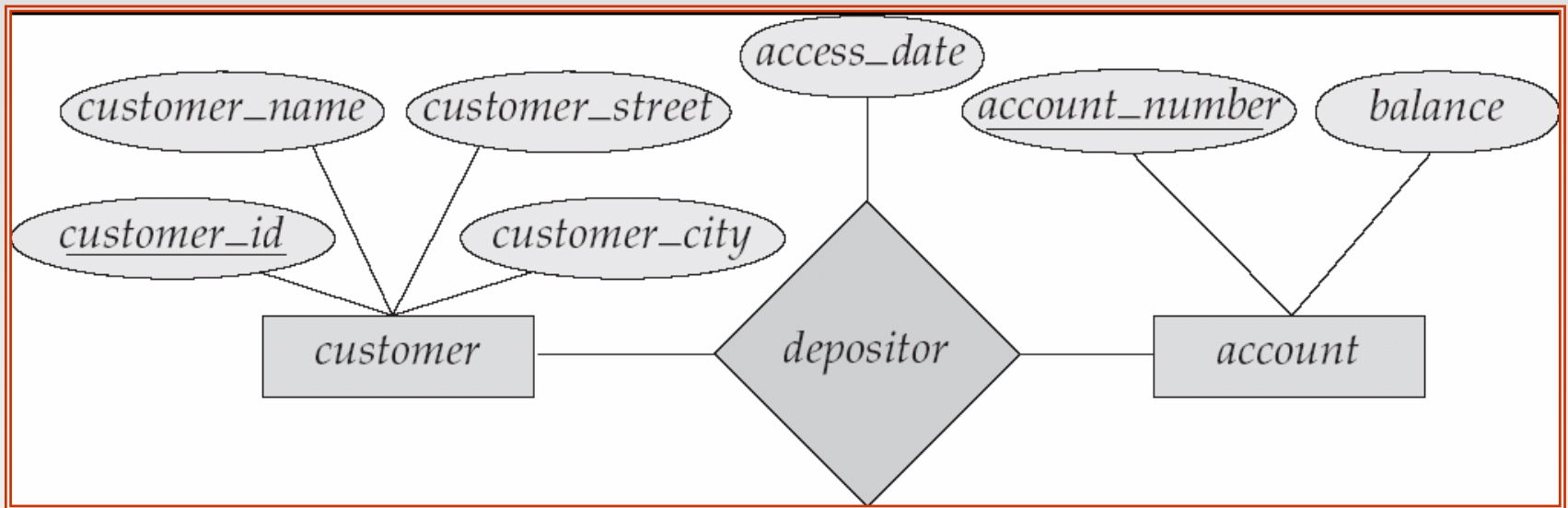



# Roles

- Entity sets of a relationship need not be distinct
- The labels “manager” and “worker” are called **roles**; they specify how employee entities interact via the works\_for relationship set.
- Roles are indicated in E-R diagrams by labeling the lines that connect diamonds to rectangles.
- Role labels are optional, and are used to clarify semantics of the relationship

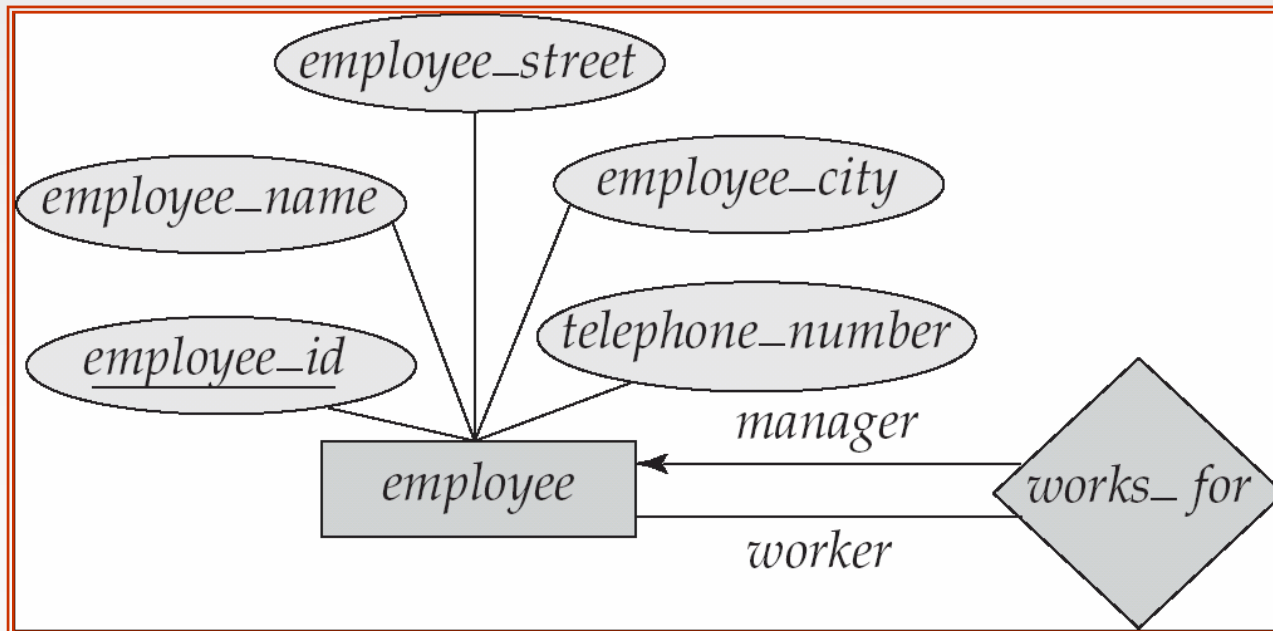



# Cardinality Constraints

- We express cardinality constraints by drawing either a directed line ( $\rightarrow$ ), signifying “one,” or an undirected line ( $—$ ), signifying “many,” between the relationship set and the entity set.
- One-to-one relationship:
  - A customer is associated with at most one loan via the relationship *borrower*
  - A loan is associated with at most one customer via *borrower*





# One-To-Many Relationship

- In the one-to-many relationship a loan is associated with at most one customer via *borrower*, a customer is associated with several (including 0) loans via *borrower*

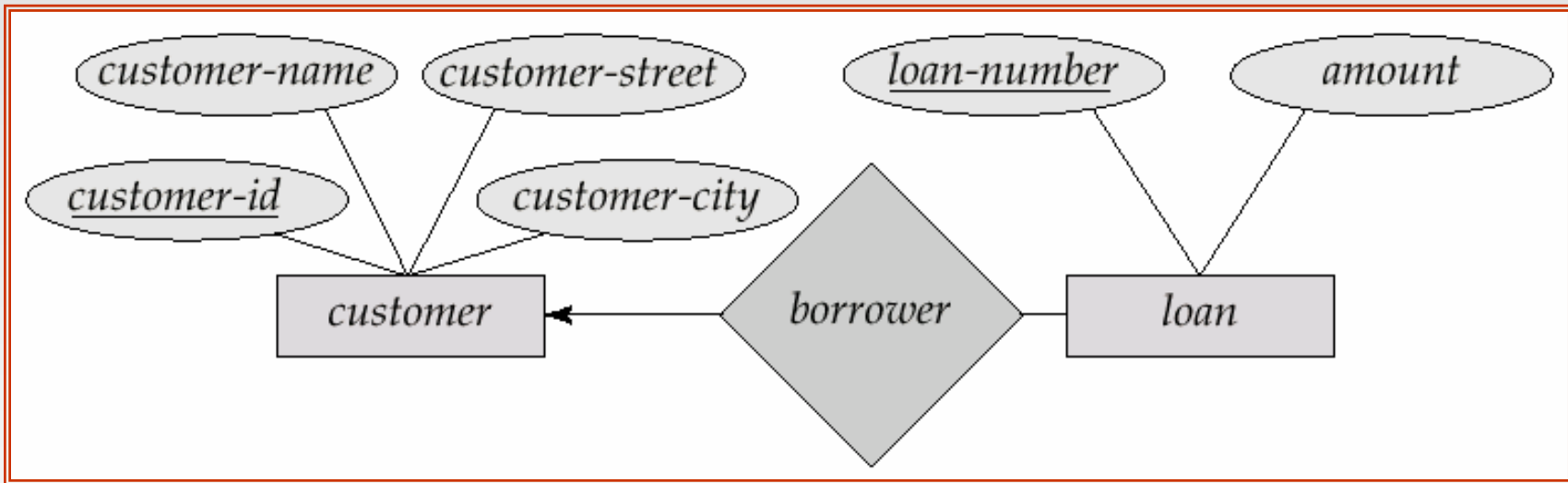



# Many-To-One Relationships

- In a many-to-one relationship a loan is associated with several (including 0) customers via *borrower*, a customer is associated with at most one loan via *borrower*

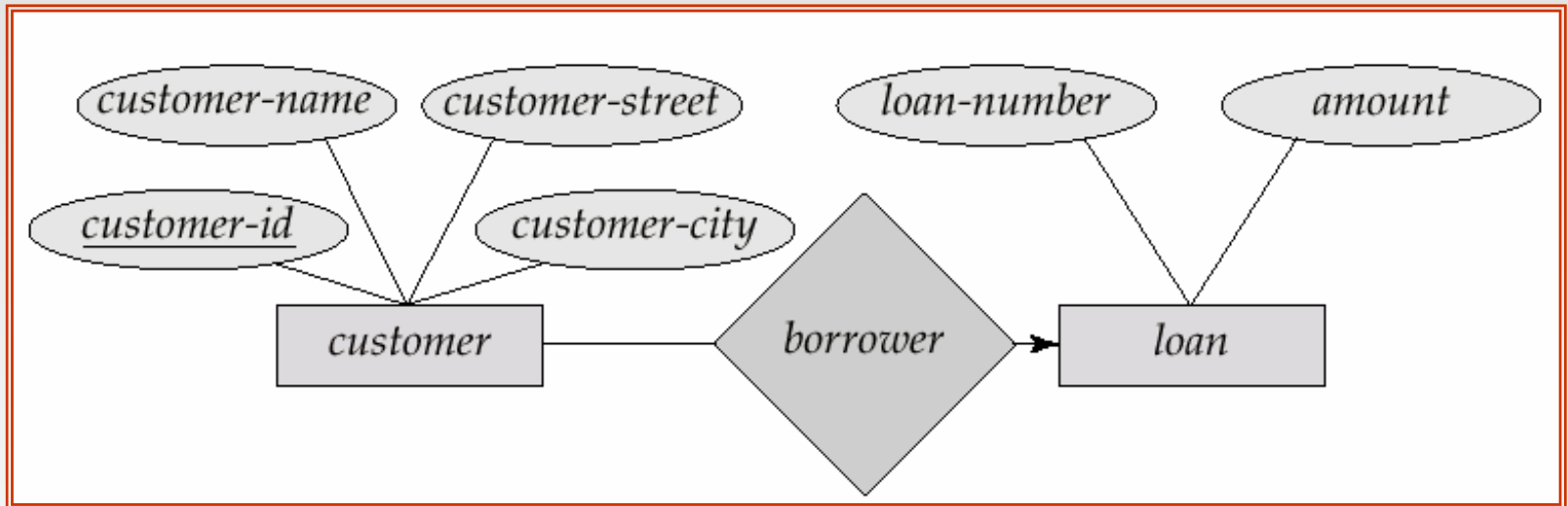



# Many-To-Many Relationship

- A customer is associated with several (possibly 0) loans via borrower
- A loan is associated with several (possibly 0) customers via borrower

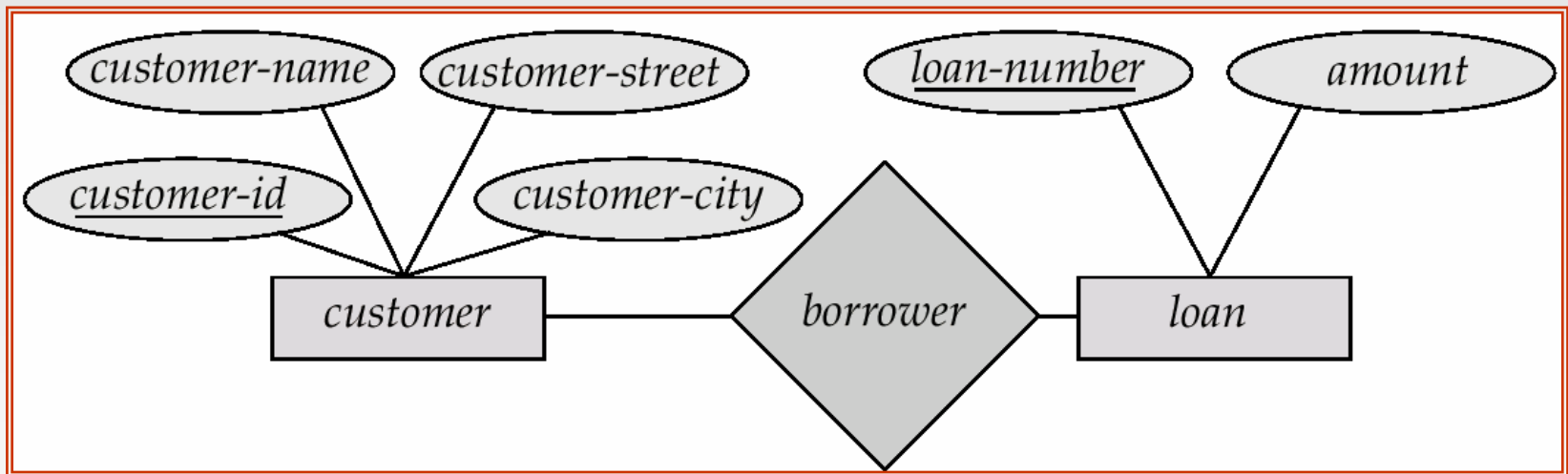



# Participation of an Entity Set in a Relationship Set

- Total participation (indicated by double line): every entity in the entity set participates in at least one relationship in the relationship set
  - E.g. participation of loan in borrower is total
    - ▶ every loan must have a customer associated to it via borrower
- Partial participation: some entities may not participate in any relationship in the relationship set
  - Example: participation of customer in borrower is partial

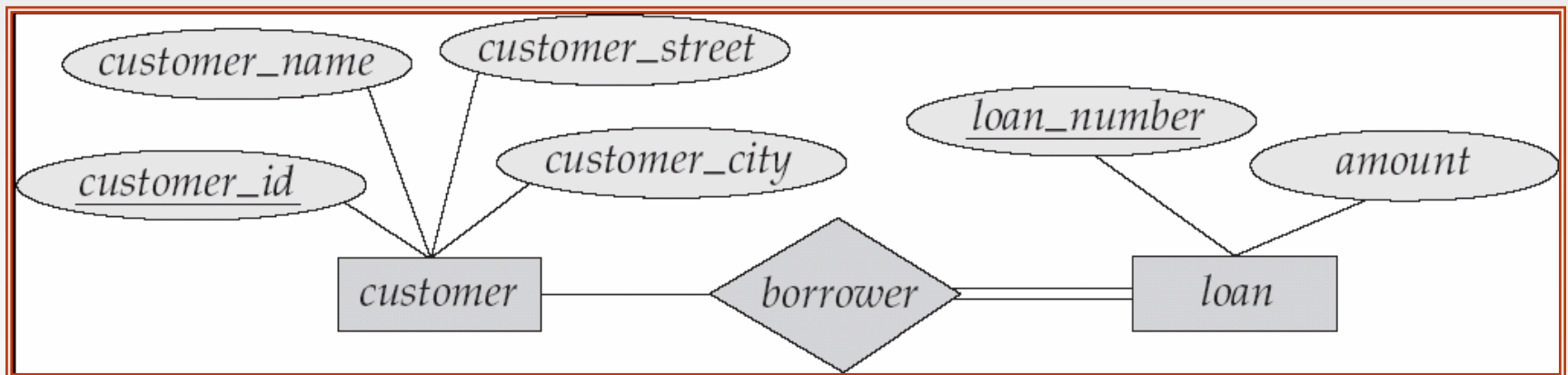





# Alternative Notation for Cardinality Limits

- Cardinality limits can also express participation constraints

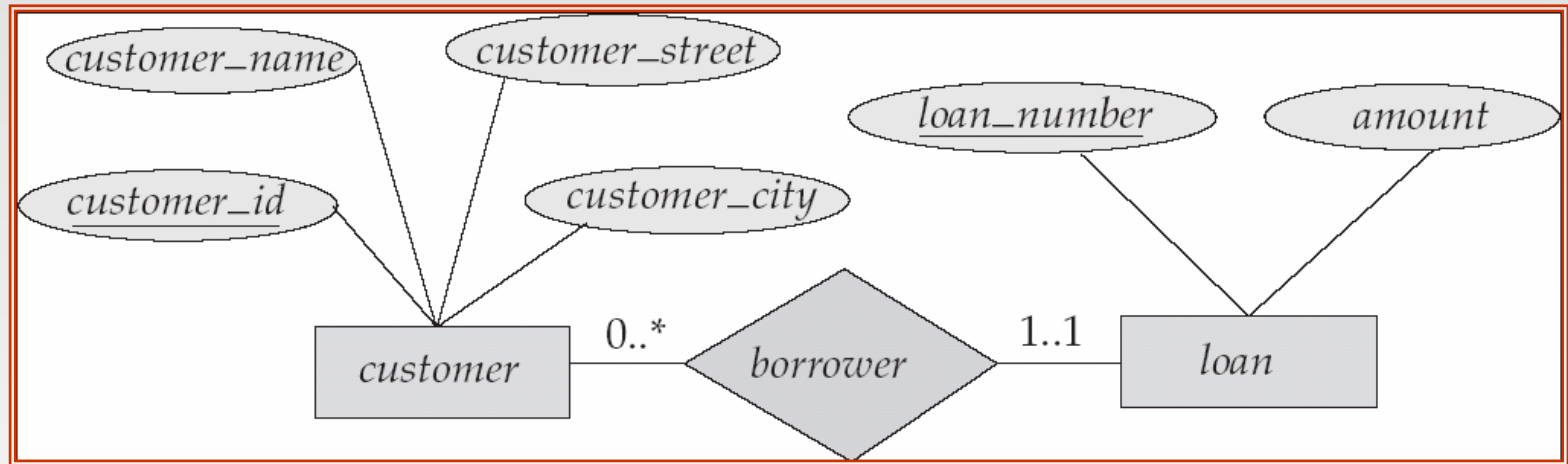



# E-R Diagram with a Ternary Relationship

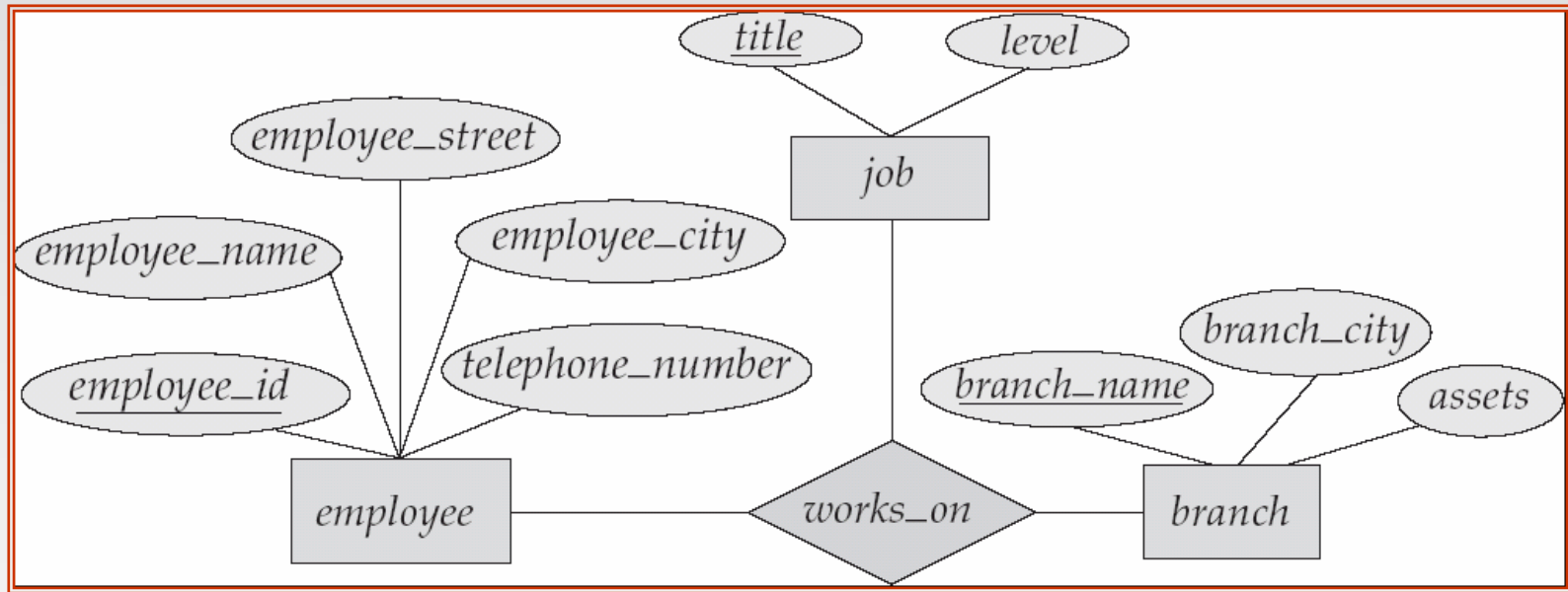



# Cardinality Constraints on Ternary Relationship

- We allow at most one arrow out of a ternary (or greater degree) relationship to indicate a cardinality constraint
- E.g. an arrow from *works\_on* to *job* indicates each employee works on at most one job at any branch.
- If there is more than one arrow, there are two ways of defining the meaning.
  - E.g a ternary relationship  $R$  between  $A$ ,  $B$  and  $C$  with arrows to  $B$  and  $C$  could mean
    1. each  $A$  entity is associated with a unique entity from  $B$  and  $C$  or
    2. each pair of entities from  $(A, B)$  is associated with a unique  $C$  entity, and each pair  $(A, C)$  is associated with a unique  $B$
  - Each alternative has been used in different formalisms
  - To avoid confusion we outlaw more than one arrow





# Design Issues

- **Use of entity sets vs. attributes**

Choice mainly depends on the structure of the enterprise being modeled, and on the semantics associated with the attribute in question.

- **Use of entity sets vs. relationship sets**

Possible guideline is to designate a relationship set to describe an action that occurs between entities

- **Binary versus n-ary relationship sets**

Although it is possible to replace any nonbinary ( $n$ -ary, for  $n > 2$ ) relationship set by a number of distinct binary relationship sets, a  $n$ -ary relationship set shows more clearly that several entities participate in a single relationship.

- **Placement of relationship attributes**





# Binary Vs. Non-Binary Relationships

- Some relationships that appear to be non-binary may be better represented using binary relationships
  - E.g. A ternary relationship *parents*, relating a child to his/her father and mother, is best replaced by two binary relationships, *father* and *mother*
    - ▶ Using two binary relationships allows partial information (e.g. only mother being know)
  - But there are some relationships that are naturally non-binary
    - ▶ Example: *works\_on*





# Converting Non-Binary Relationships to Binary Form

- In general, any non-binary relationship can be represented using binary relationships by creating an artificial entity set.
  - Replace  $R$  between entity sets  $A$ ,  $B$  and  $C$  by an entity set  $E$ , and three relationship sets:
    1.  $R_A$ , relating  $E$  and  $A$
    2.  $R_B$ , relating  $E$  and  $B$
    3.  $R_C$ , relating  $E$  and  $C$
  - Create a special identifying attribute for  $E$
  - Add any attributes of  $R$  to  $E$
  - For each relationship  $(a_i, b_i, c_i)$  in  $R$ , create
    1. a new entity  $e_i$  in the entity set  $E$
    2. add  $(e_i, a_i)$  to  $R_A$
    3. add  $(e_i, b_i)$  to  $R_B$
    4. add  $(e_i, c_i)$  to  $R_C$

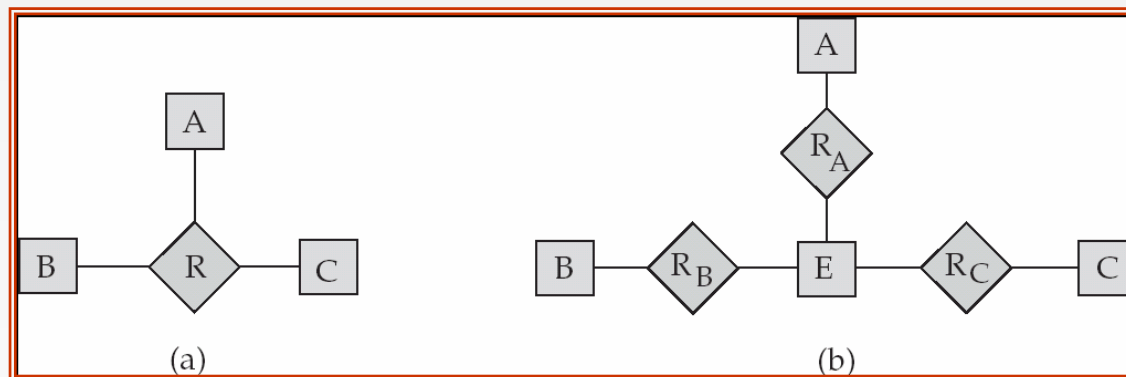



# Converting Non-Binary Relationships (Cont.)

- Also need to translate constraints
  - Translating all constraints may not be possible
  - There may be instances in the translated schema that cannot correspond to any instance of  $R$ 
    - ▶ Exercise: *add constraints to the relationships  $R_A$ ,  $R_B$  and  $R_C$  to ensure that a newly created entity corresponds to exactly one entity in each of entity sets  $A$ ,  $B$  and  $C$*
  - We can avoid creating an identifying attribute by making  $E$  a weak entity set (described shortly) identified by the three relationship sets





# Mapping Cardinalities affect ER Design

- Can make access-date an attribute of account, instead of a relationship attribute, if each account can have only one customer
  - That is, the relationship from account to customer is many to one, or equivalently, customer to account is one to many

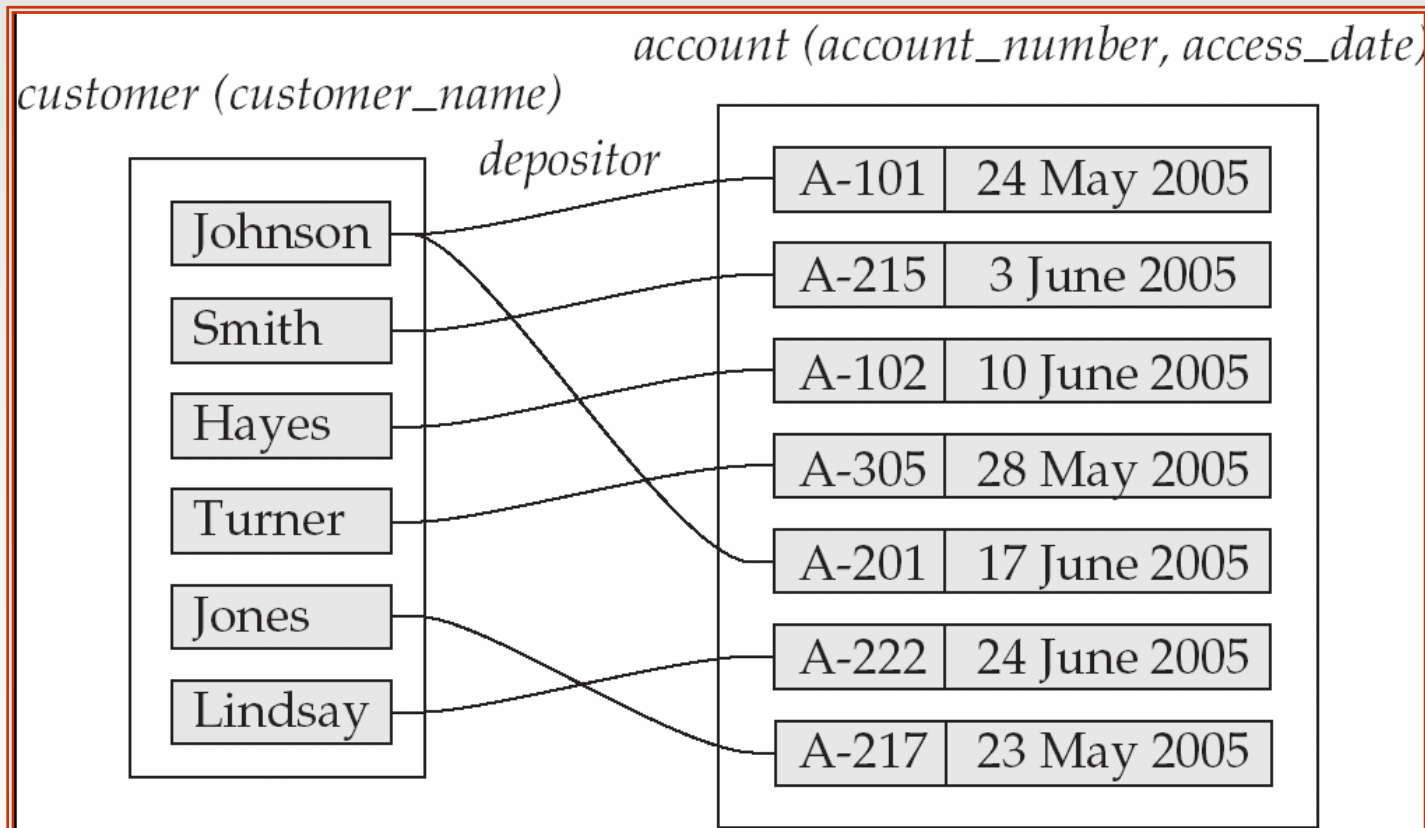





**How about doing an ER design  
interactively on the board?  
Suggest an application to be modeled.**

**Database System Concepts, 5th Ed.**

©Silberschatz, Korth and Sudarshan  
See [www.db-book.com](http://www.db-book.com) for conditions on re-use





# Weak Entity Sets

- An entity set that does not have a primary key is referred to as a **weak entity set**.
- The existence of a weak entity set depends on the existence of a **identifying entity set**
  - it must relate to the identifying entity set via a total, one-to-many relationship set from the identifying to the weak entity set
  - **Identifying relationship** depicted using a double diamond
- The **discriminator** (*or partial key*) of a weak entity set is the set of attributes that distinguishes among all the entities of a weak entity set.
- The primary key of a weak entity set is formed by the primary key of the strong entity set on which the weak entity set is existence dependent, plus the weak entity set's discriminator.





# Weak Entity Sets (Cont.)

- We depict a weak entity set by double rectangles.
- We underline the discriminator of a weak entity set with a dashed line.
- `payment_number` – discriminator of the *payment* entity set
- Primary key for *payment* –  $(loan\_number, payment\_number)$

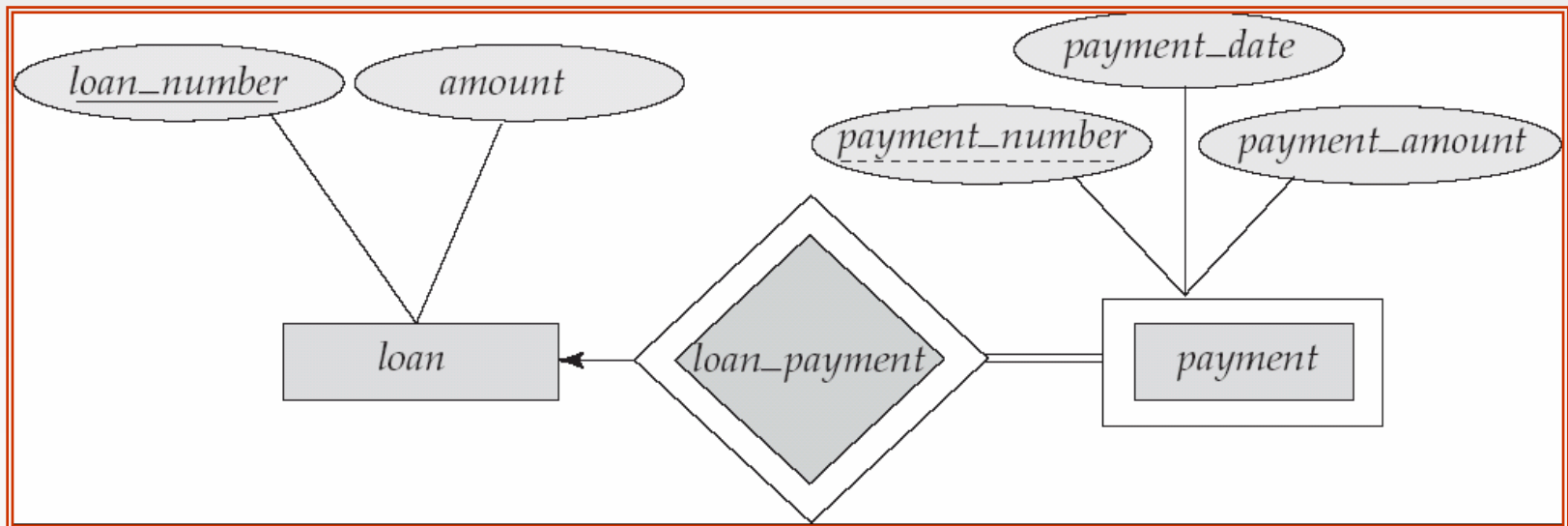



# Weak Entity Sets (Cont.)

- Note: the primary key of the strong entity set is not explicitly stored with the weak entity set, since it is implicit in the identifying relationship.
- If *loan\_number* were explicitly stored, *payment* could be made a strong entity, but then the relationship between *payment* and *loan* would be duplicated by an implicit relationship defined by the attribute *loan\_number* common to *payment* and *loan*





# More Weak Entity Set Examples

- In a university, a *course* is a strong entity and a *course\_offering* can be modeled as a weak entity
- The discriminator of *course\_offering* would be *semester* (including year) and *section\_number* (if there is more than one section)
- If we model *course\_offering* as a strong entity we would model *course\_number* as an attribute.

Then the relationship with *course* would be implicit in the *course\_number* attribute





# Extended E-R Features: Specialization

- Top-down design process; we designate subgroupings within an entity set that are distinctive from other entities in the set.
- These subgroupings become lower-level entity sets that have attributes or participate in relationships that do not apply to the higher-level entity set.
- Depicted by a *triangle* component labeled ISA (E.g. *customer* “is a” *person*).
- **Attribute inheritance** – a lower-level entity set inherits all the attributes and relationship participation of the higher-level entity set to which it is linked.





# Specialization Example

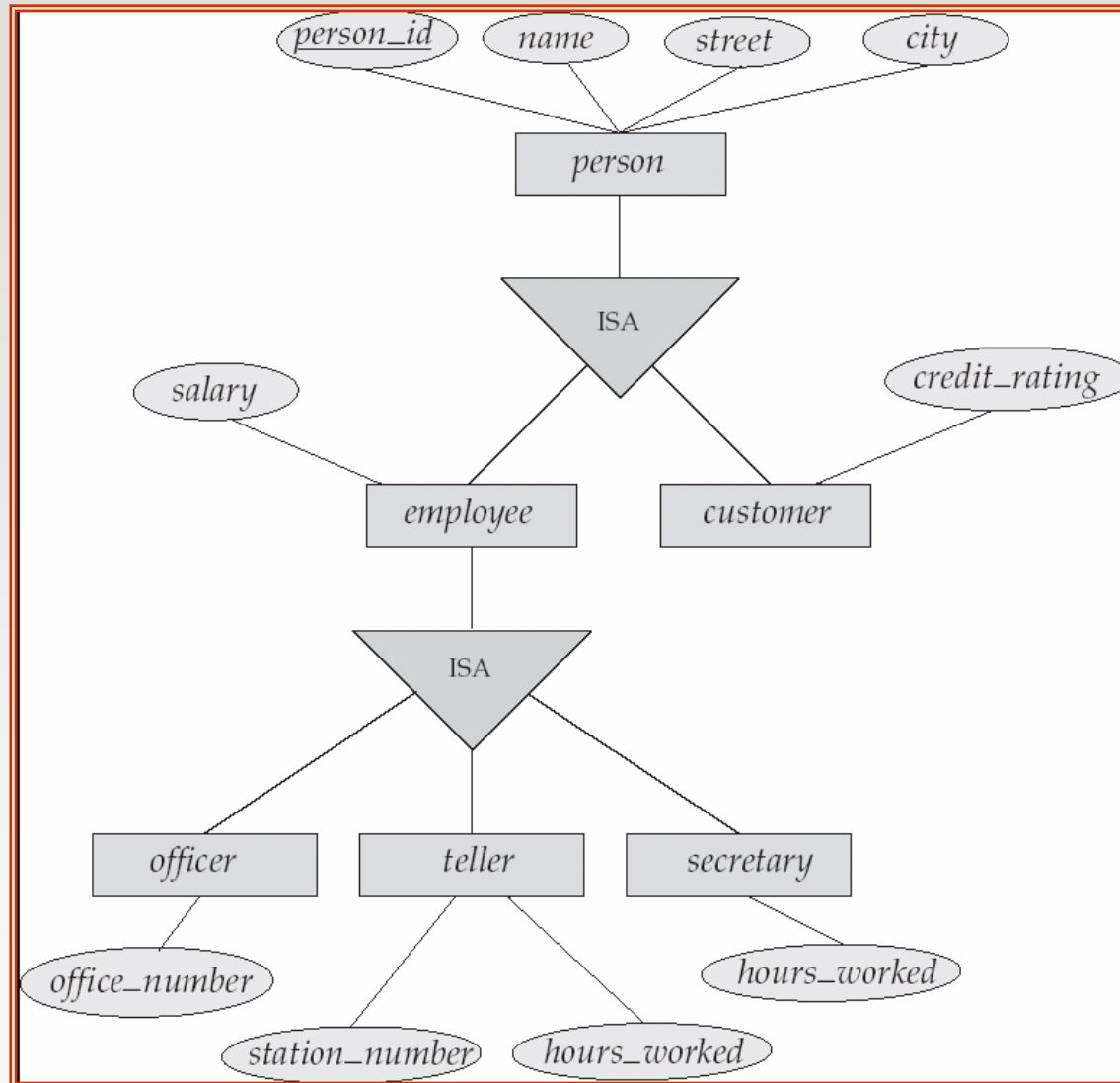



# Extended ER Features: Generalization

- **A bottom-up design process** – combine a number of entity sets that share the same features into a higher-level entity set.
- Specialization and generalization are simple inversions of each other; they are represented in an E-R diagram in the same way.
- The terms specialization and generalization are used interchangeably.







# Specialization and Generalization (Cont.)

- Can have multiple specializations of an entity set based on different features.
- E.g. *permanent\_employee* vs. *temporary\_employee*, in addition to *officer* vs. *secretary* vs. *teller*
- Each particular employee would be
  - a member of one of *permanent\_employee* or *temporary\_employee*,
  - and also a member of one of *officer*, *secretary*, or *teller*
- The ISA relationship also referred to as **superclass - subclass** relationship





# Design Constraints on a Specialization/Generalization

- Constraint on which entities can be members of a given lower-level entity set.
  - condition-defined
    - ▶ Example: all customers over 65 years are members of *senior-citizen* entity set; *senior-citizen* ISA *person*.
  - user-defined
- Constraint on whether or not entities may belong to more than one lower-level entity set within a single generalization.
  - **Disjoint**
    - ▶ an entity can belong to only one lower-level entity set
    - ▶ Noted in E-R diagram by writing *disjoint* next to the ISA triangle
  - **Overlapping**
    - ▶ an entity can belong to more than one lower-level entity set





# Design Constraints on a Specialization/Generalization (Cont.)

- **Completeness constraint** -- specifies whether or not an entity in the higher-level entity set must belong to at least one of the lower-level entity sets within a generalization.
  - **total** : an entity must belong to one of the lower-level entity sets
  - **partial**: an entity need not belong to one of the lower-level entity sets





# Aggregation

- Consider the ternary relationship *works\_on*, which we saw earlier
- Suppose we want to record managers for tasks performed by an employee at a branch

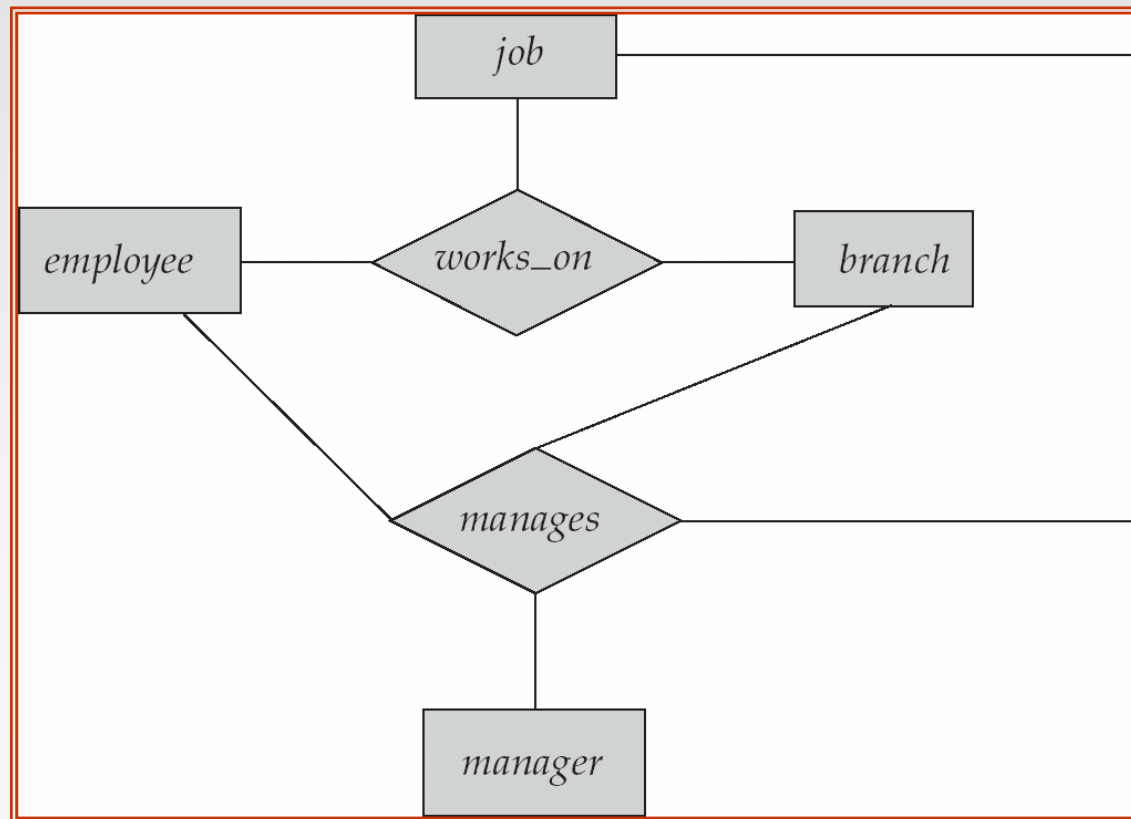



# Aggregation (Cont.)

- Relationship sets *works\_on* and *manages* represent overlapping information
  - Every *manages* relationship corresponds to a *works\_on* relationship
  - However, some *works\_on* relationships may not correspond to any *manages* relationships
    - ▶ So we can't discard the *works\_on* relationship
- Eliminate this redundancy via *aggregation*
  - Treat relationship as an abstract entity
  - Allows relationships between relationships
  - Abstraction of relationship into new entity
- Without introducing redundancy, the following diagram represents:
  - An employee works on a particular job at a particular branch
  - An employee, branch, job combination may have an associated manager





# E-R Diagram With Aggregation

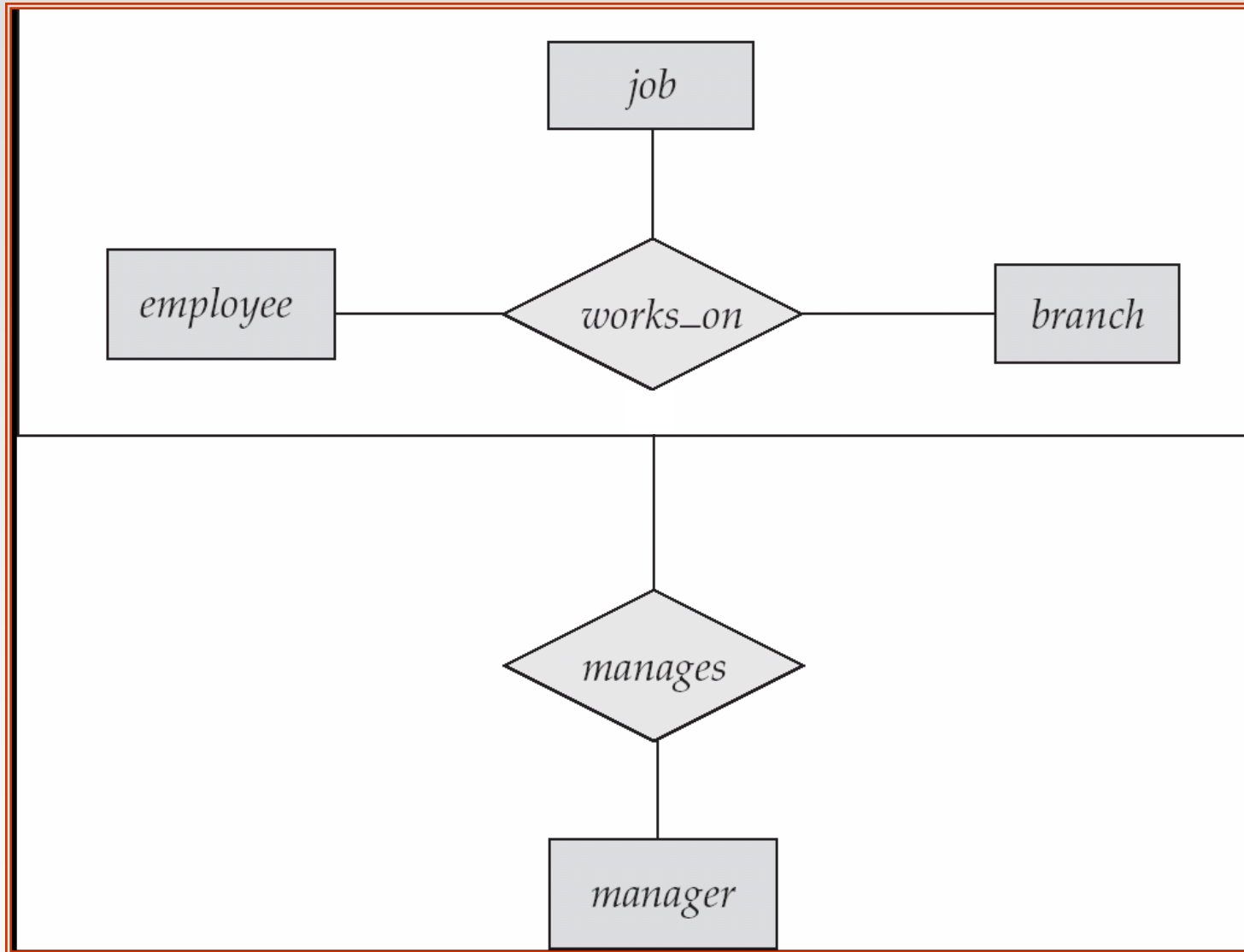



# E-R Design Decisions

- The use of an attribute or entity set to represent an object.
- Whether a real-world concept is best expressed by an entity set or a relationship set.
- The use of a ternary relationship versus a pair of binary relationships.
- The use of a strong or weak entity set.
- The use of specialization/generalization – contributes to modularity in the design.
- The use of aggregation – can treat the aggregate entity set as a single unit without concern for the details of its internal structure.





# E-R Diagram for a Banking Enterprise

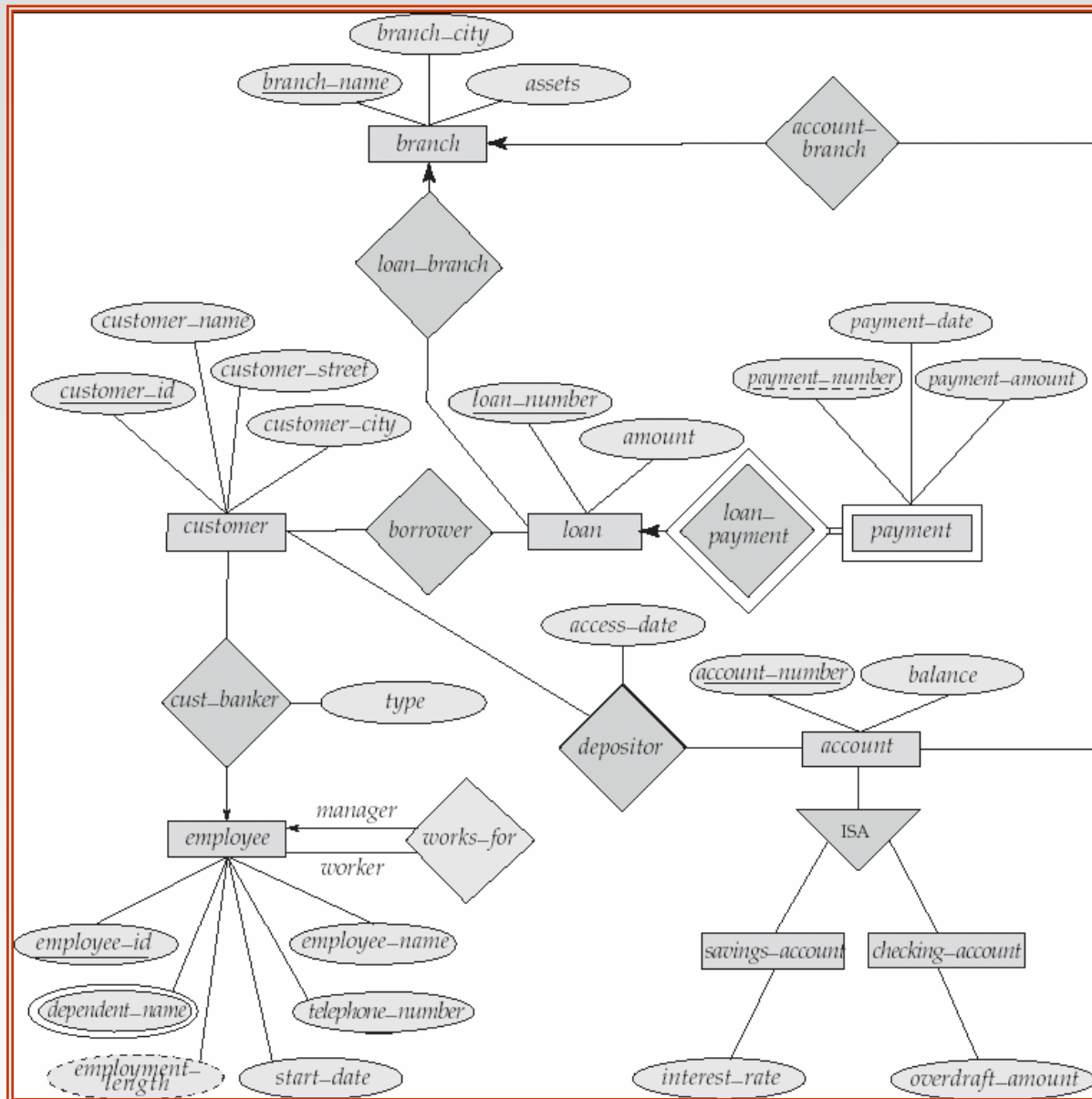





# How about doing another ER design interactively on the board?

**Database System Concepts, 5th Ed.**

©Silberschatz, Korth and Sudarshan  
See [www.db-book.com](http://www.db-book.com) for conditions on re-use





# Summary of Symbols Used in E-R Notation

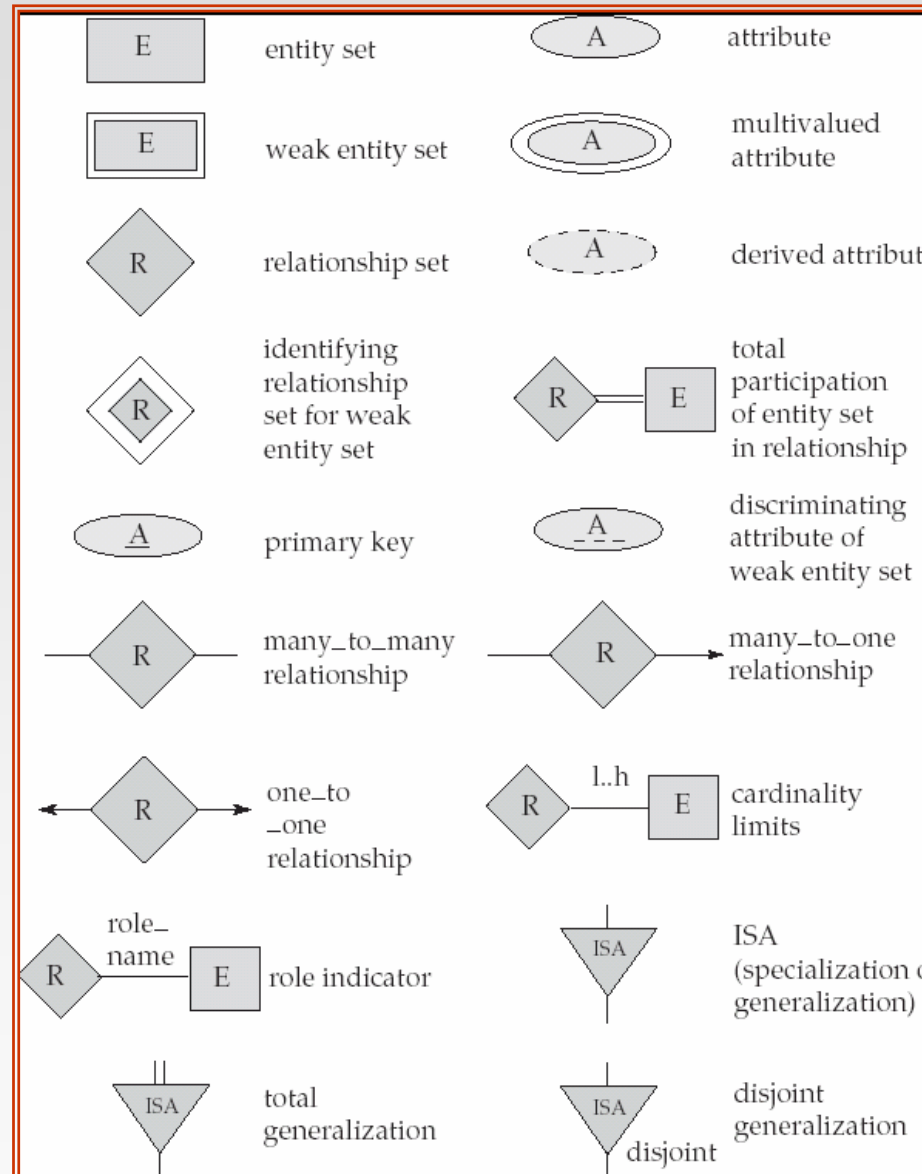



# Summary of Symbols (Cont.)

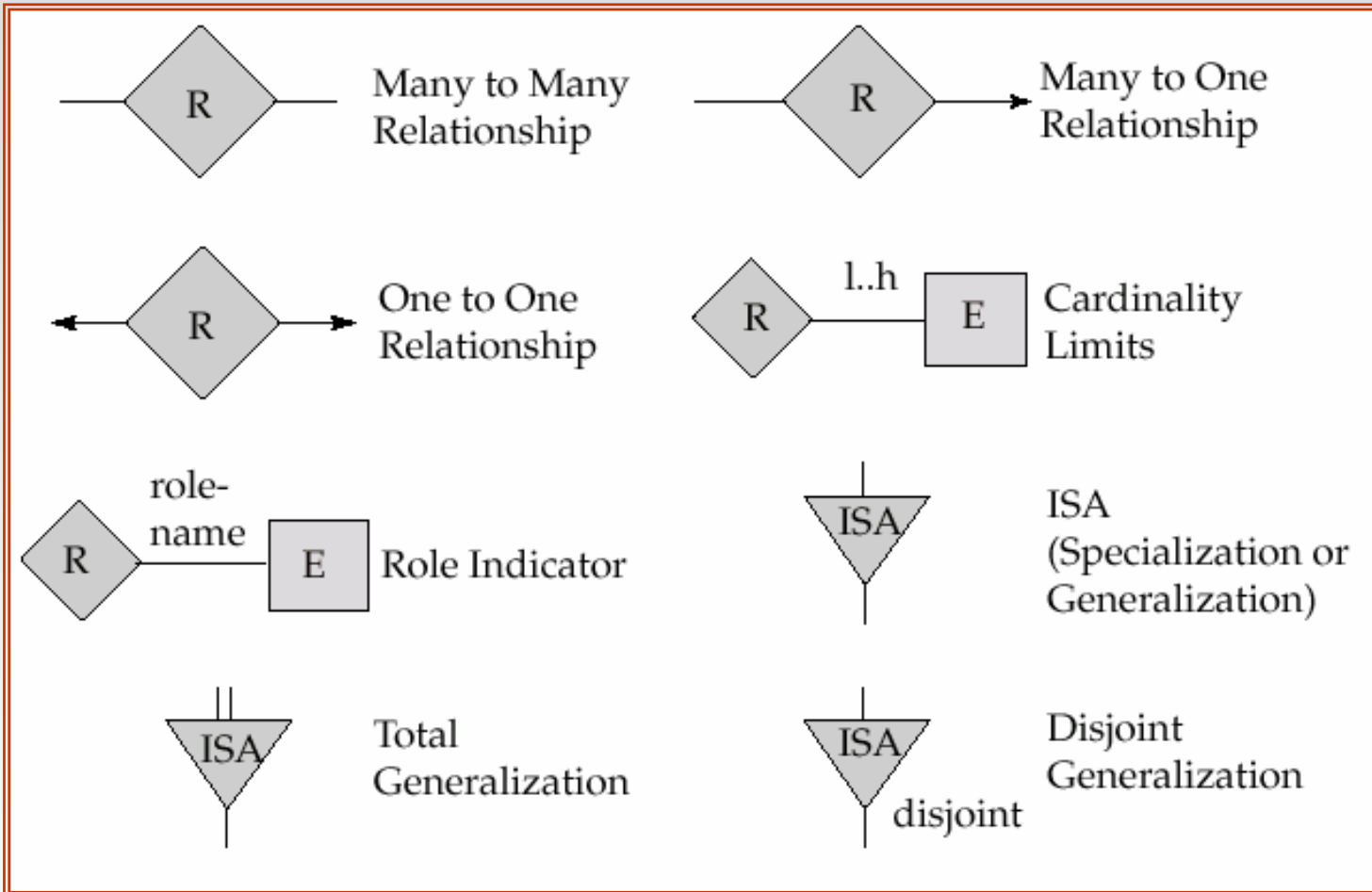



# Reduction to Relation Schemas

- Primary keys allow entity sets and relationship sets to be expressed uniformly as *relation schemas* that represent the contents of the database.
- A database which conforms to an E-R diagram can be represented by a collection of schemas.
- For each entity set and relationship set there is a unique schema that is assigned the name of the corresponding entity set or relationship set.
- Each schema has a number of columns (generally corresponding to attributes), which have unique names.





# Representing Entity Sets as Schemas

- A strong entity set reduces to a schema with the same attributes.
- A weak entity set becomes a table that includes a column for the primary key of the identifying strong entity set

*payment* =

( *loan\_number*, *payment\_number*, *payment\_date*, *payment\_amount* )





# Representing Relationship Sets as Schemas

- A many-to-many relationship set is represented as a schema with attributes for the primary keys of the two participating entity sets, and any descriptive attributes of the relationship set.
- Example: schema for relationship set borrower

*borrower = (customer\_id, loan\_number)*





# Redundancy of Schemas

- Many-to-one and one-to-many relationship sets that are total on the many-side can be represented by adding an extra attribute to the “many” side, containing the primary key of the “one” side
- Example: Instead of creating a schema for relationship set *account\_branch*, add an attribute *branch\_name* to the schema arising from entity set *account*

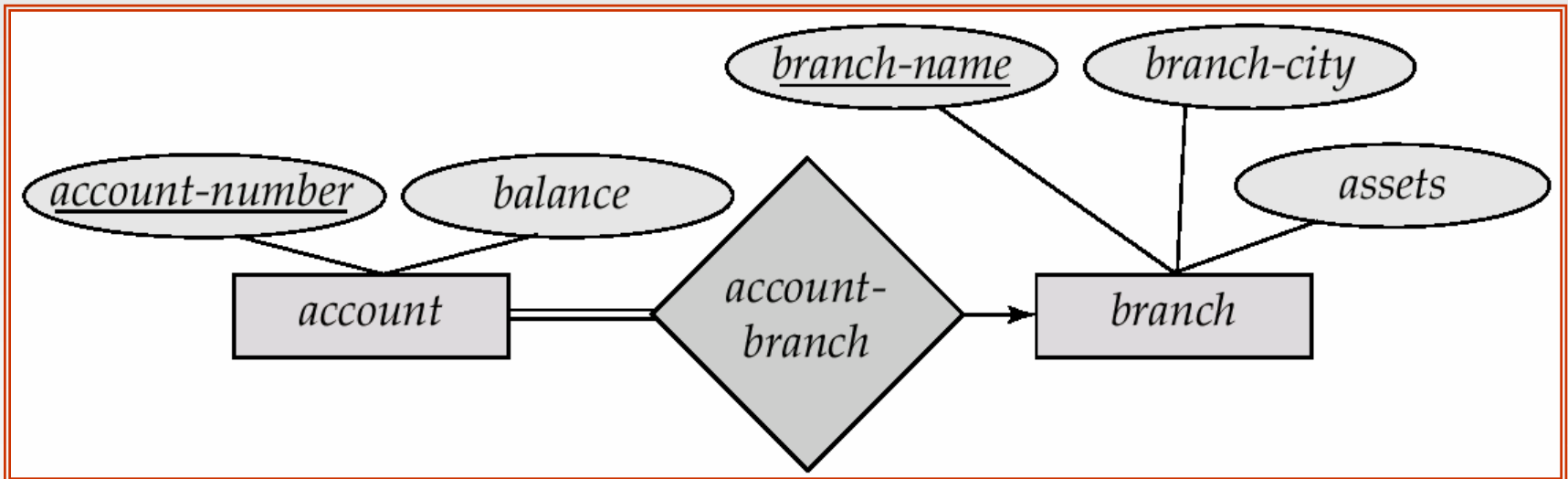



# Redundancy of Schemas (Cont.)

- For one-to-one relationship sets, either side can be chosen to act as the “many” side
  - That is, extra attribute can be added to either of the tables corresponding to the two entity sets
- If participation is *partial* on the “many” side, replacing a schema by an extra attribute in the schema corresponding to the “many” side could result in null values
- The schema corresponding to a relationship set linking a weak entity set to its identifying strong entity set is redundant.
  - Example: The *payment* schema already contains the attributes that would appear in the *loan\_payment* schema (i.e., *loan\_number* and *payment\_number*).







# Composite and Multivalued Attributes

- Composite attributes are flattened out by creating a separate attribute for each component attribute
  - Example: given entity set *customer* with composite attribute *name* with component attributes *first\_name* and *last\_name* the schema corresponding to the entity set has two attributes  
*name.first\_name* and *name.last\_name*
- A multivalued attribute *M* of an entity *E* is represented by a separate schema *EM*
  - Schema *EM* has attributes corresponding to the primary key of *E* and an attribute corresponding to multivalued attribute *M*
  - Example: Multivalued attribute *dependent\_names* of *employee* is represented by a schema:  
*employee\_dependent\_names* = ( *employee\_id*, *dname* )
  - Each value of the multivalued attribute maps to a separate tuple of the relation on schema *EM*
    - ▶ For example, an employee entity with primary key 123-45-6789 and dependents Jack and Jane maps to two tuples:  
(123-45-6789 , Jack) and (123-45-6789 , Jane)





# Representing Specialization via Schemas

- Method 1:
  - Form a schema for the higher-level entity
  - Form a schema for each lower-level entity set, include primary key of higher-level entity set and local attributes

schema	attributes
<i>person</i>	<i>name, street, city</i>
<i>customer</i>	<i>name, credit_rating</i>
<i>employee</i>	<i>name, salary</i>

- Drawback: getting information about, an *employee* requires accessing two relations, the one corresponding to the low-level schema and the one corresponding to the high-level schema





# Representing Specialization as Schemas (Cont.)

- Method 2:
  - Form a schema for each entity set with all local and inherited attributes

<i>schema</i>	<i>attributes</i>
<i>person</i>	<i>name, street, city</i>
<i>customer</i>	<i>name, street, city, credit_rating</i>
<i>employee</i>	<i>name, street, city, salary</i>

- If specialization is total, the schema for the generalized entity set (*person*) not required to store information
  - ▶ Can be defined as a “view” relation containing union of specialization relations
  - ▶ But explicit schema may still be needed for foreign key constraints
- Drawback: *street* and *city* may be stored redundantly for people who are both customers and employees





# Schemas Corresponding to Aggregation

- To represent aggregation, create a schema containing
  - primary key of the aggregated relationship,
  - the primary key of the associated entity set
  - any descriptive attributes





# Schemas Corresponding to Aggregation (Cont.)

- For example, to represent aggregation manages between relationship *works\_on* and entity set *manager*, create a schema

*manages* (*employee\_id*, *branch\_name*, *title*, *manager\_name*)

- Schema *works\_on* is redundant provided we are willing to store null values for attribute *manager\_name* in relation on schema *manages*

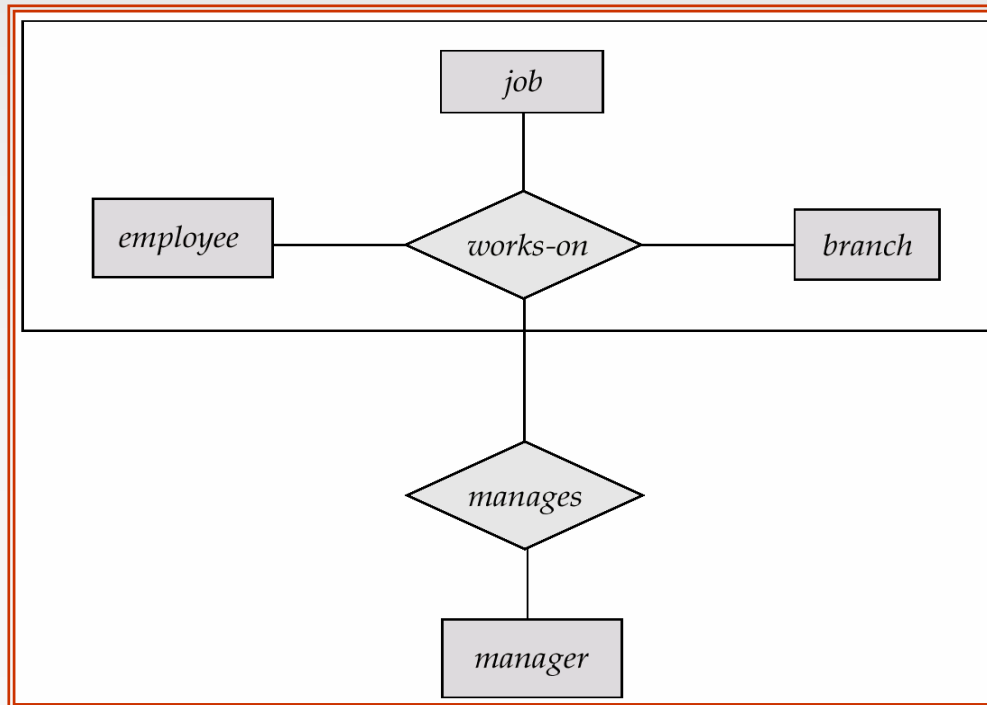



# UML

- **UML:** Unified Modeling Language
- UML has many components to graphically model different aspects of an entire software system
- UML Class Diagrams correspond to E-R Diagram, but several differences.





# Summary of UML Class Diagram Notation

## 1. Entity sets and attributes

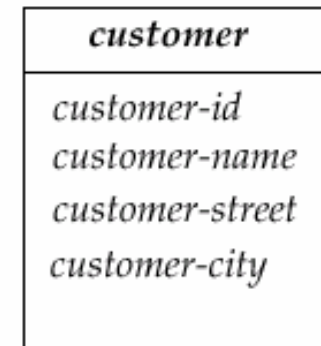
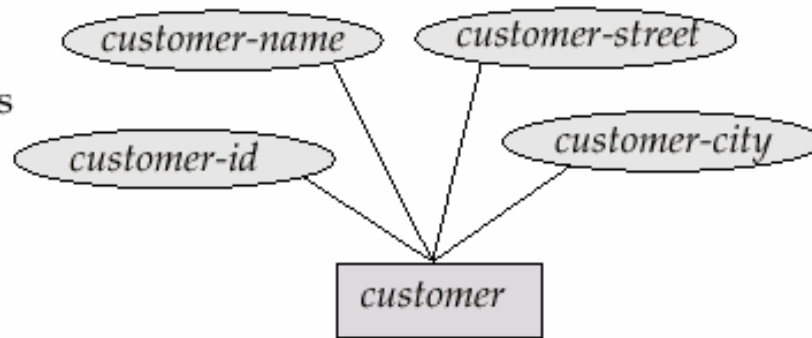

## 2. Relationships

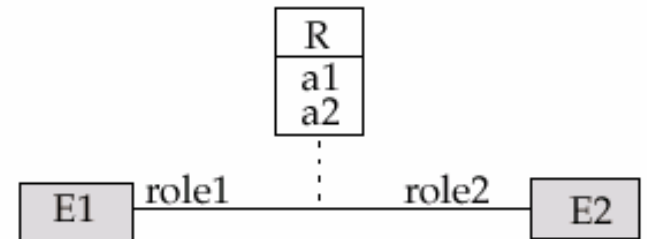
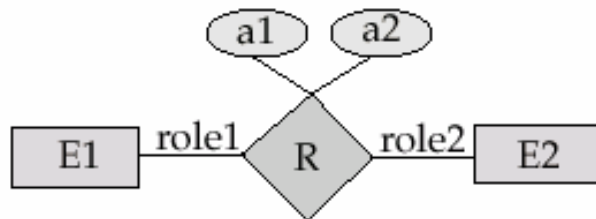
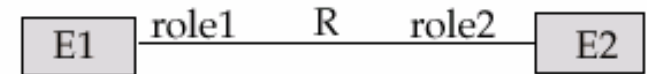
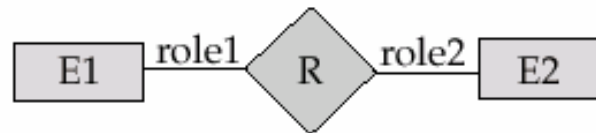



# UML Class Diagrams (Cont.)

- Entity sets are shown as boxes, and attributes are shown within the box, rather than as separate ellipses in E-R diagrams.
- Binary relationship sets are represented in UML by just drawing a line connecting the entity sets. The relationship set name is written adjacent to the line.
- The role played by an entity set in a relationship set may also be specified by writing the role name on the line, adjacent to the entity set.
- The relationship set name may alternatively be written in a box, along with attributes of the relationship set, and the box is connected, using a dotted line, to the line depicting the relationship set.
- Non-binary relationships drawn using diamonds, just as in ER diagrams







# UML Class Diagram Notation (Cont.)

3. Cardinality constraints

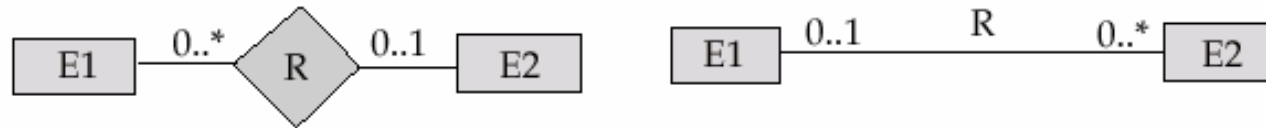

4. Generalization and Specialization

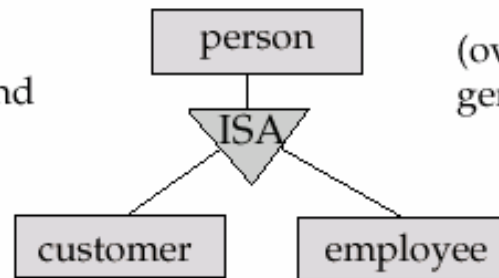

(overlapping generalization)

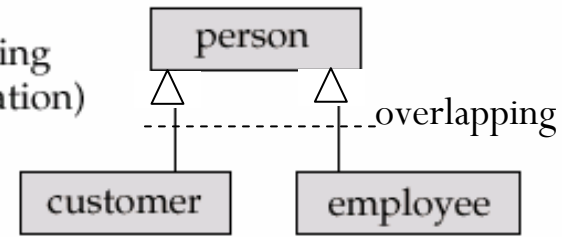

(disjoint generalization)

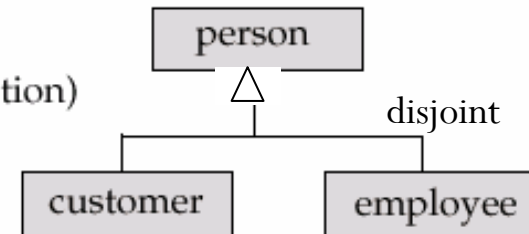
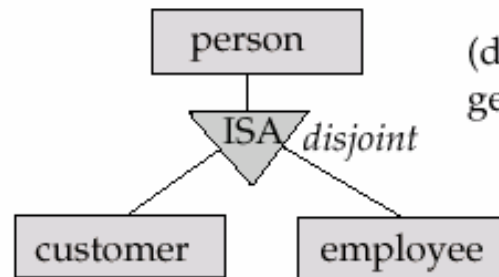

\*Note reversal of position in cardinality constraint depiction

\*Generalization can use merged or separate arrows independent of disjoint/overlapping





# UML Class Diagrams (Contd.)

- Cardinality constraints are specified in the form  $l..h$ , where  $l$  denotes the minimum and  $h$  the maximum number of relationships an entity can participate in.
- Beware: the positioning of the constraints is exactly the reverse of the positioning of constraints in E-R diagrams.
- The constraint  $0..*$  on the  $E2$  side and  $0..1$  on the  $E1$  side means that each  $E2$  entity can participate in at most one relationship, whereas each  $E1$  entity can participate in many relationships; in other words, the relationship is many to one from  $E2$  to  $E1$ .
- Single values, such as 1 or \* may be written on edges; The single value 1 on an edge is treated as equivalent to  $1..1$ , while \* is equivalent to  $0..*$ .





# End of Chapter 2

**Database System Concepts, 5th Ed.**

©Silberschatz, Korth and Sudarshan  
See [www.db-book.com](http://www.db-book.com) for conditions on re-use





# E-R Diagram for Exercise 2.10

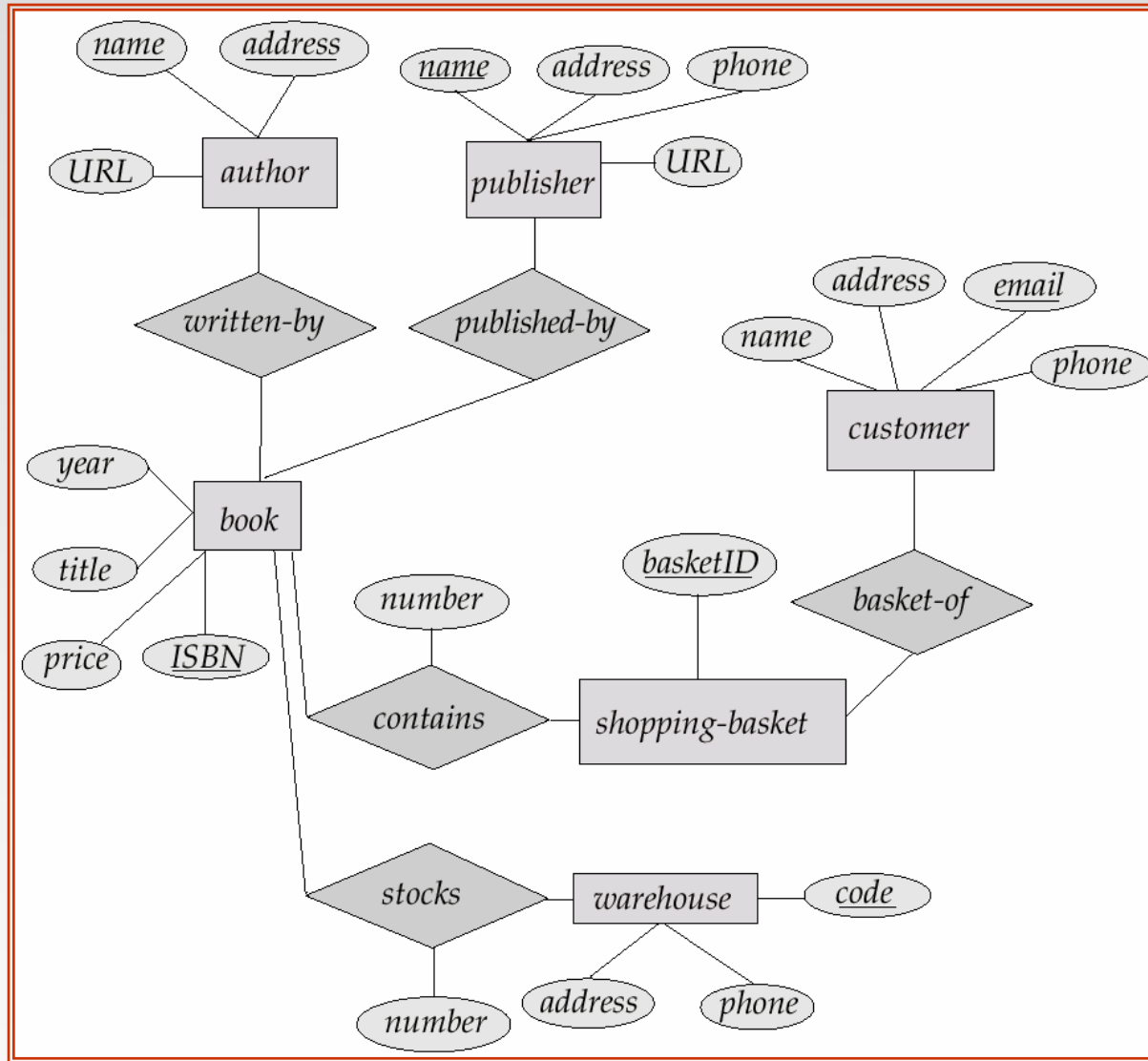



# E-R Diagram for Exercise 2.15

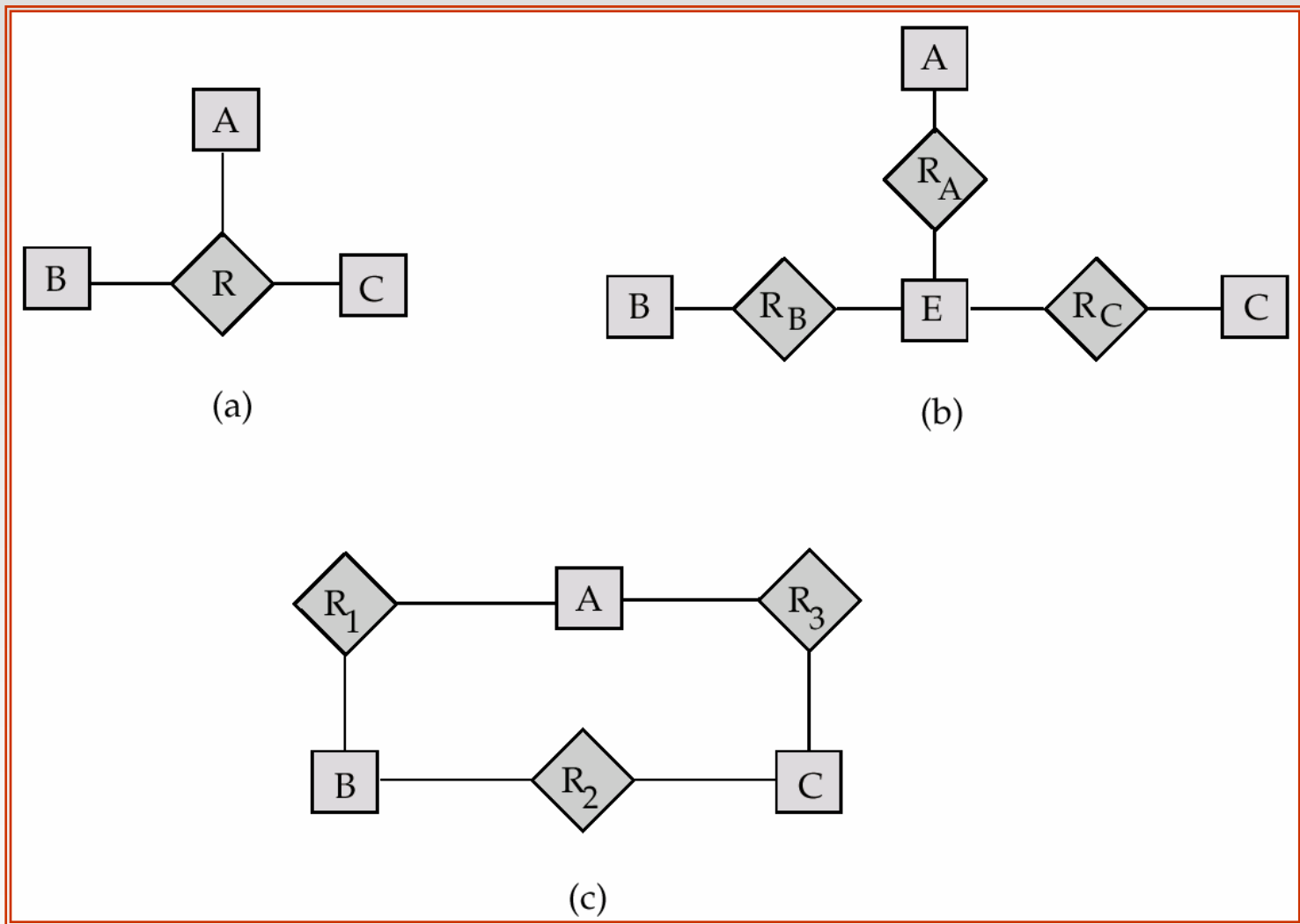



# E-R Diagram for Exercise 2.22

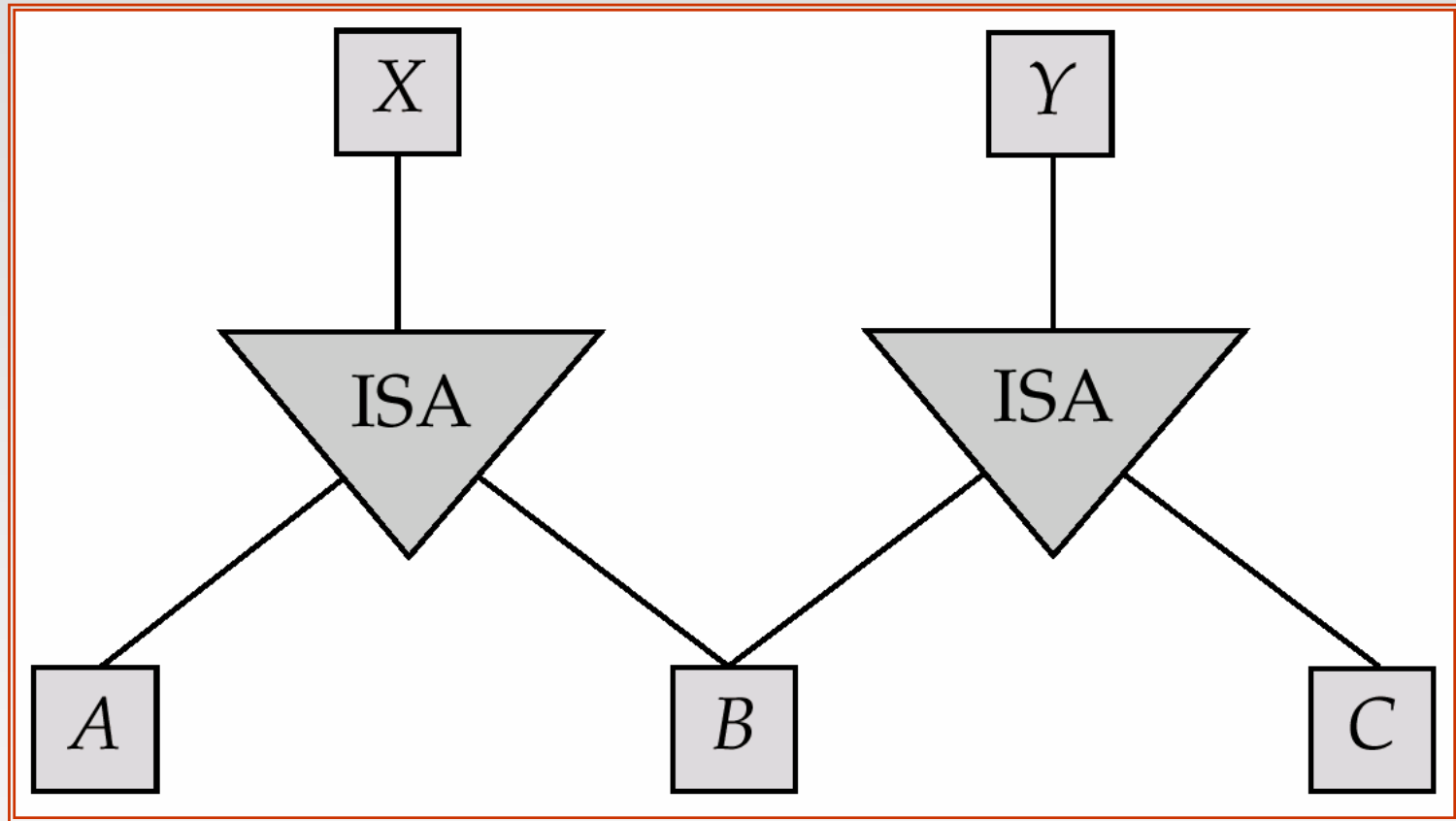



# E-R Diagram for Exercise 2.15

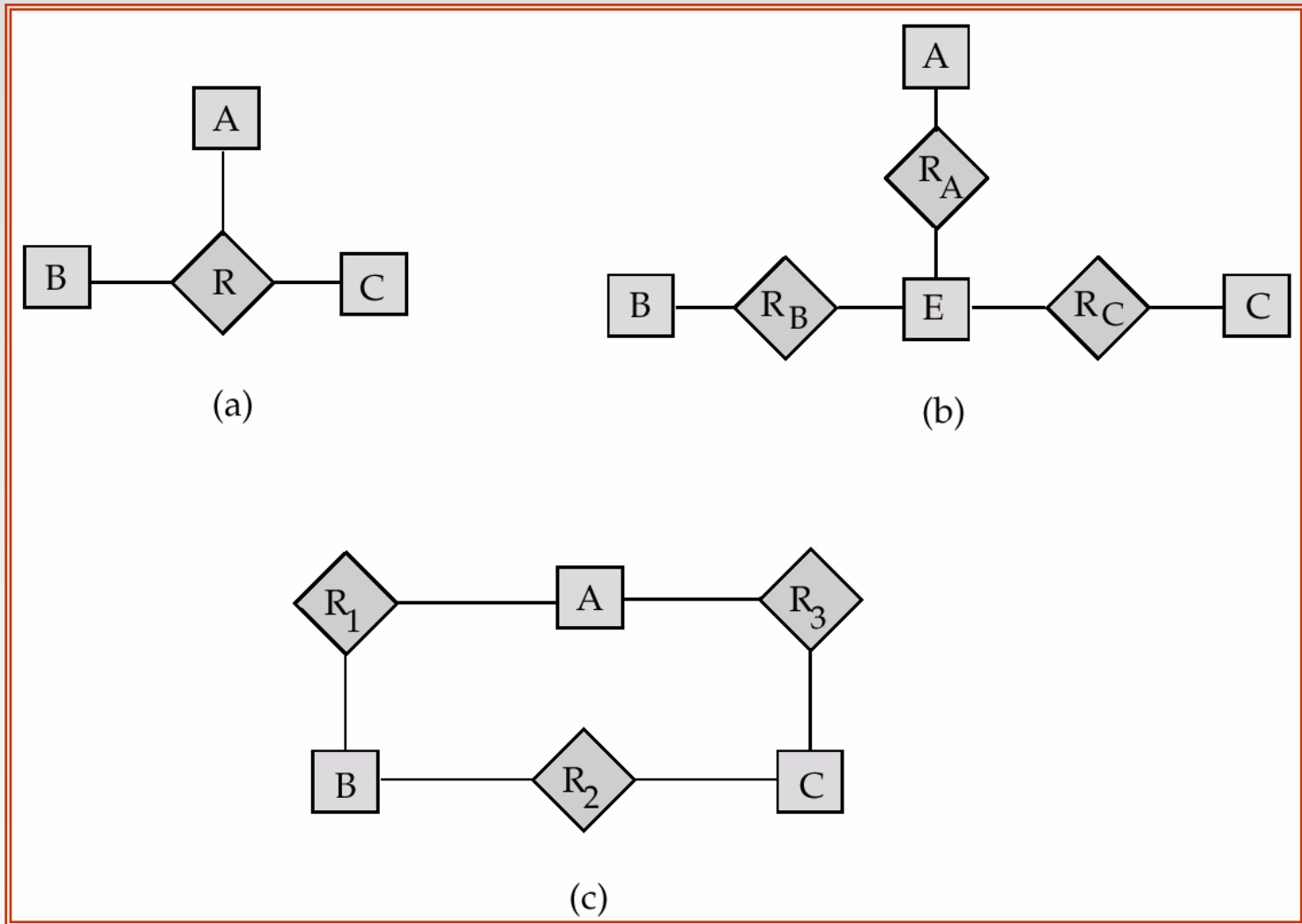



# Existence Dependencies

- If the existence of entity  $x$  depends on the existence of entity  $y$ , then  $x$  is said to be *existence dependent* on  $y$ .
  - $y$  is a *dominant entity* (in example below, *loan*)
  - $x$  is a *subordinate entity* (in example below, *payment*)

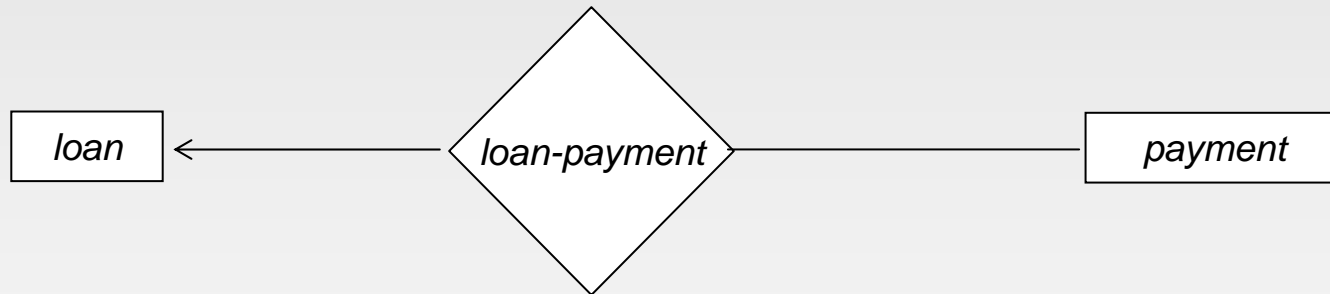

If a *loan* entity is deleted, then all its associated *payment* entities must be deleted also.







# Figure 6.8

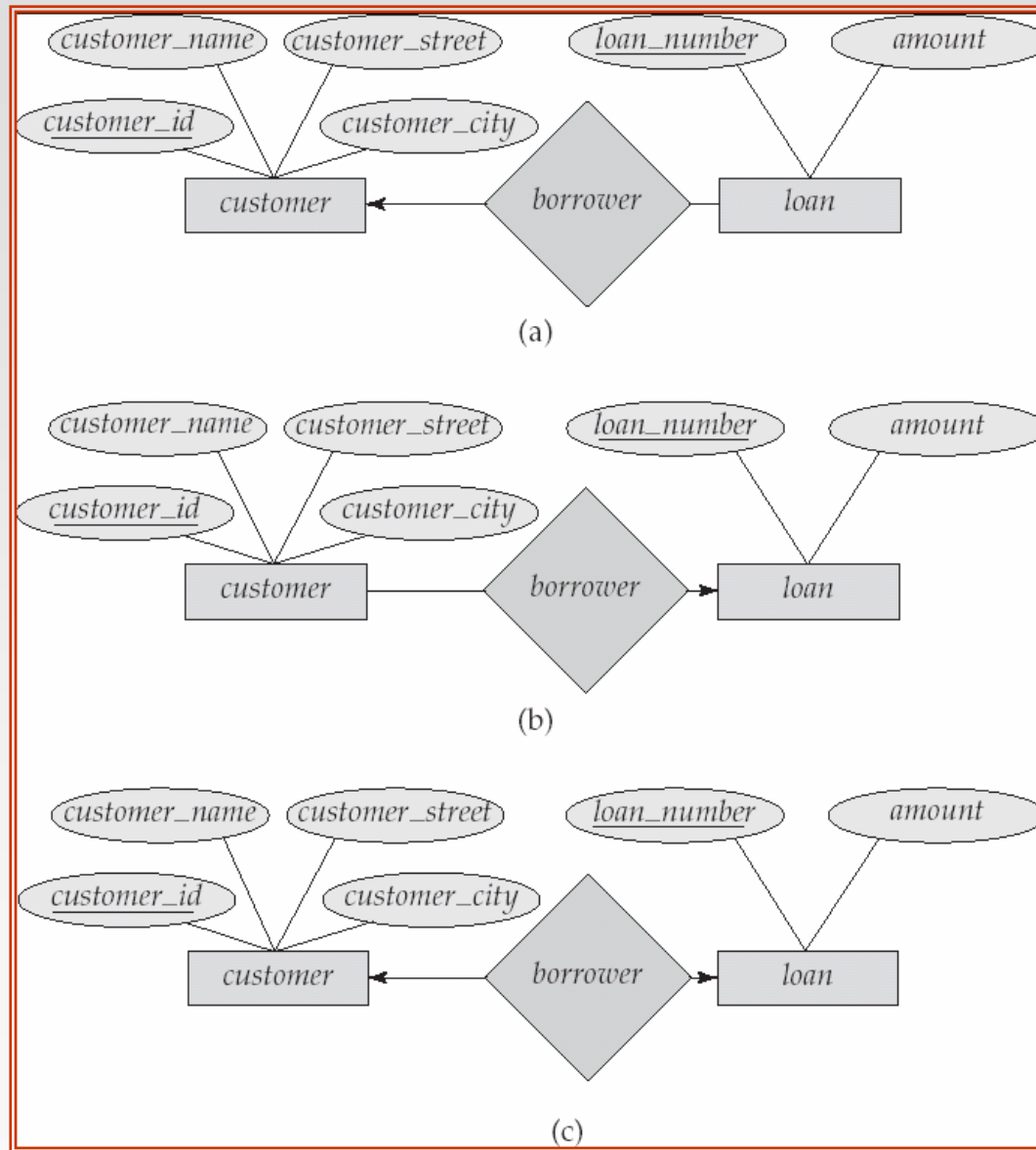



# Figure 6.15

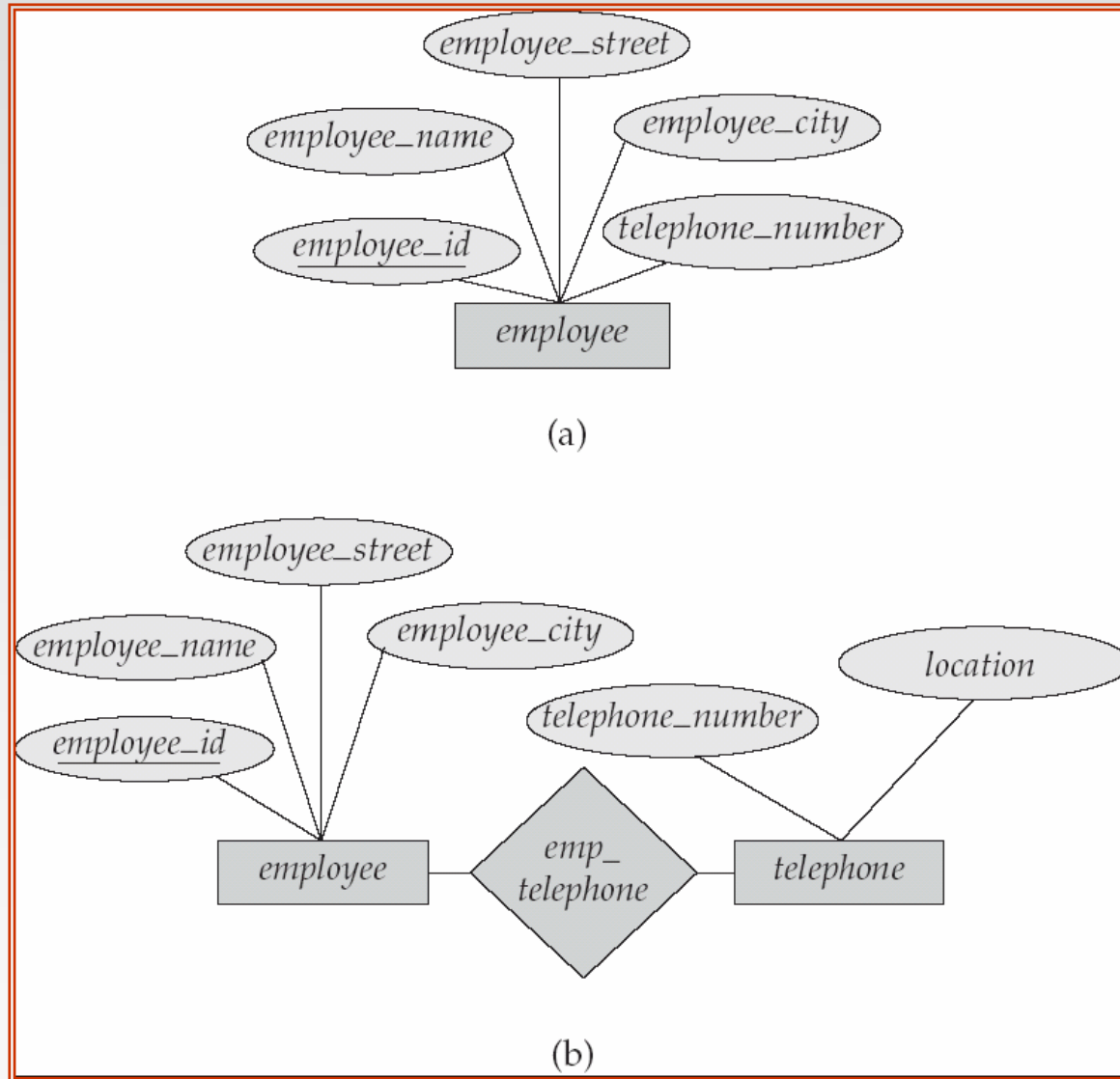



# Figure 6.16

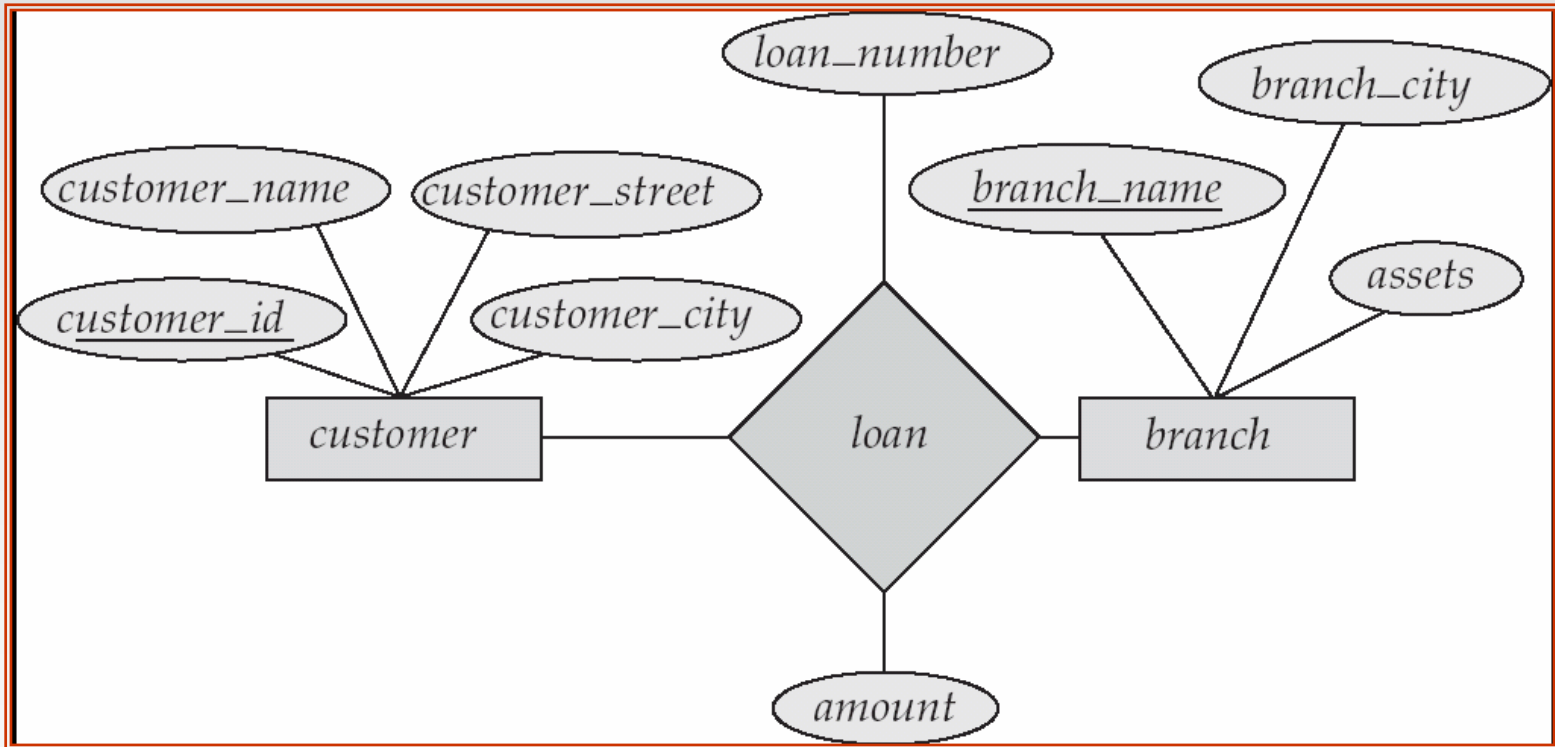



# Figure 6.26

<i>loan_number</i>	<i>amount</i>
L-11	900
L-14	1500
L-15	1500
L-16	1300
L-17	1000
L-23	2000
L-93	500





# Figure 6.27

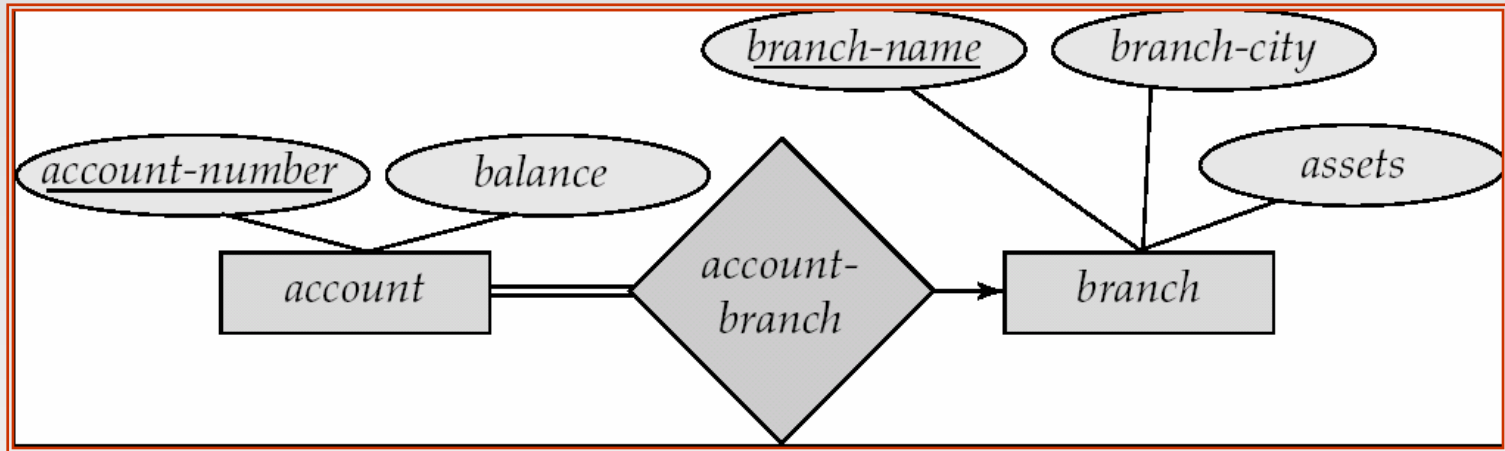



# Figure 6.28

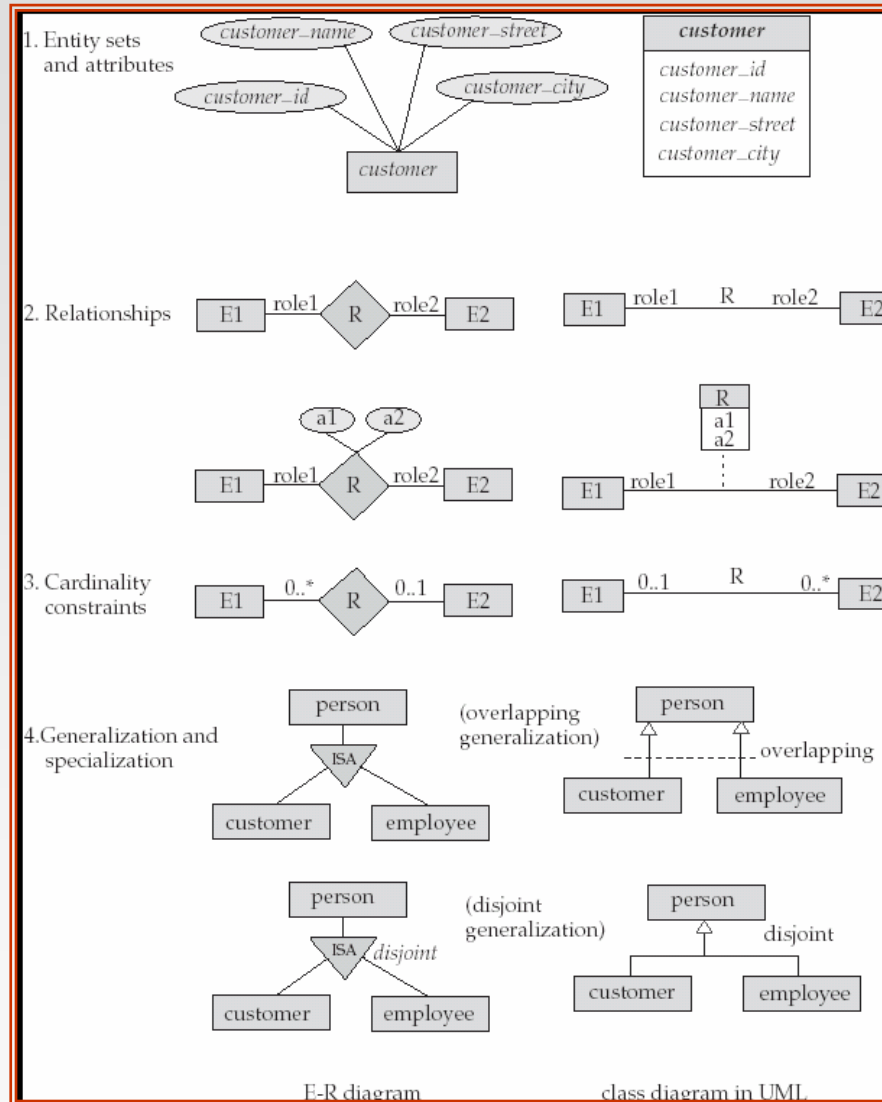



# Figure 6.29

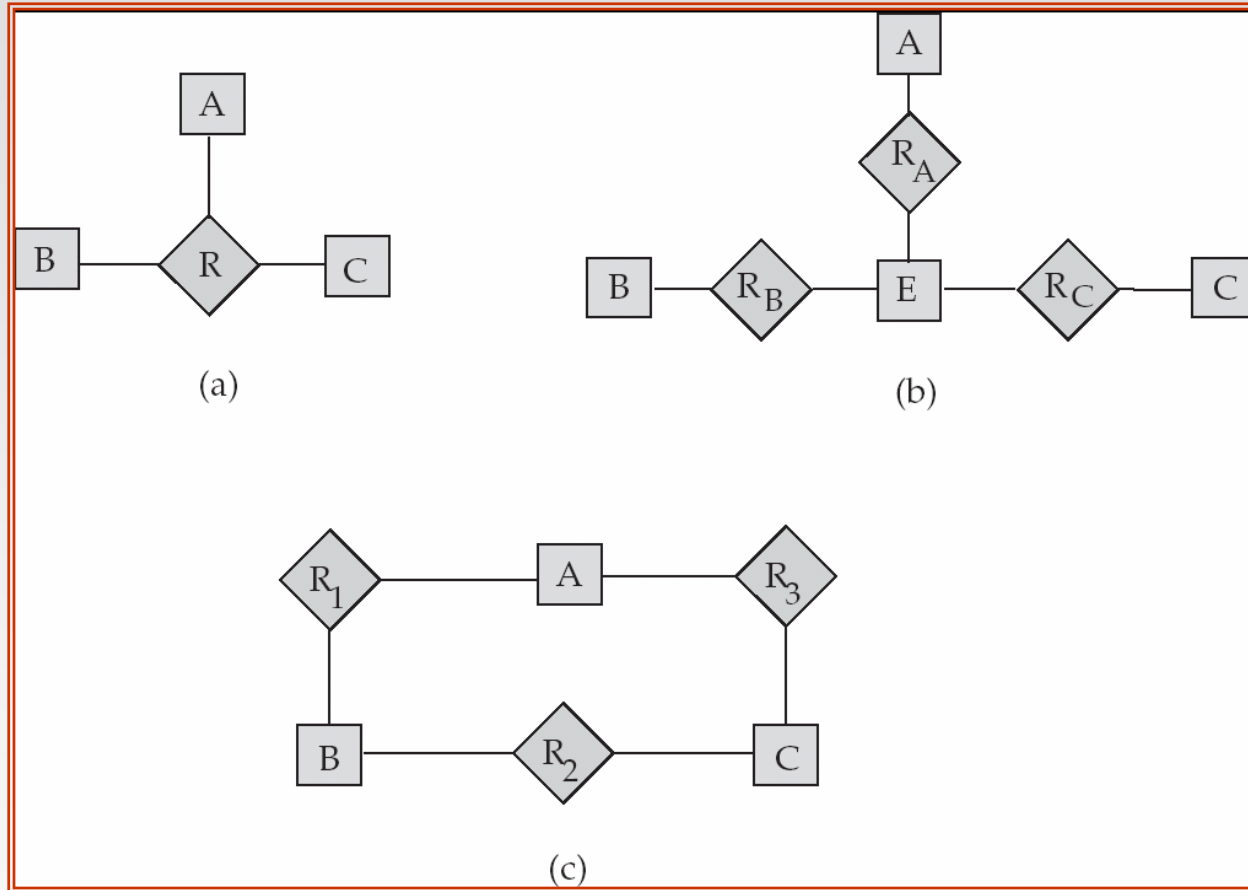



# Figure 6.30

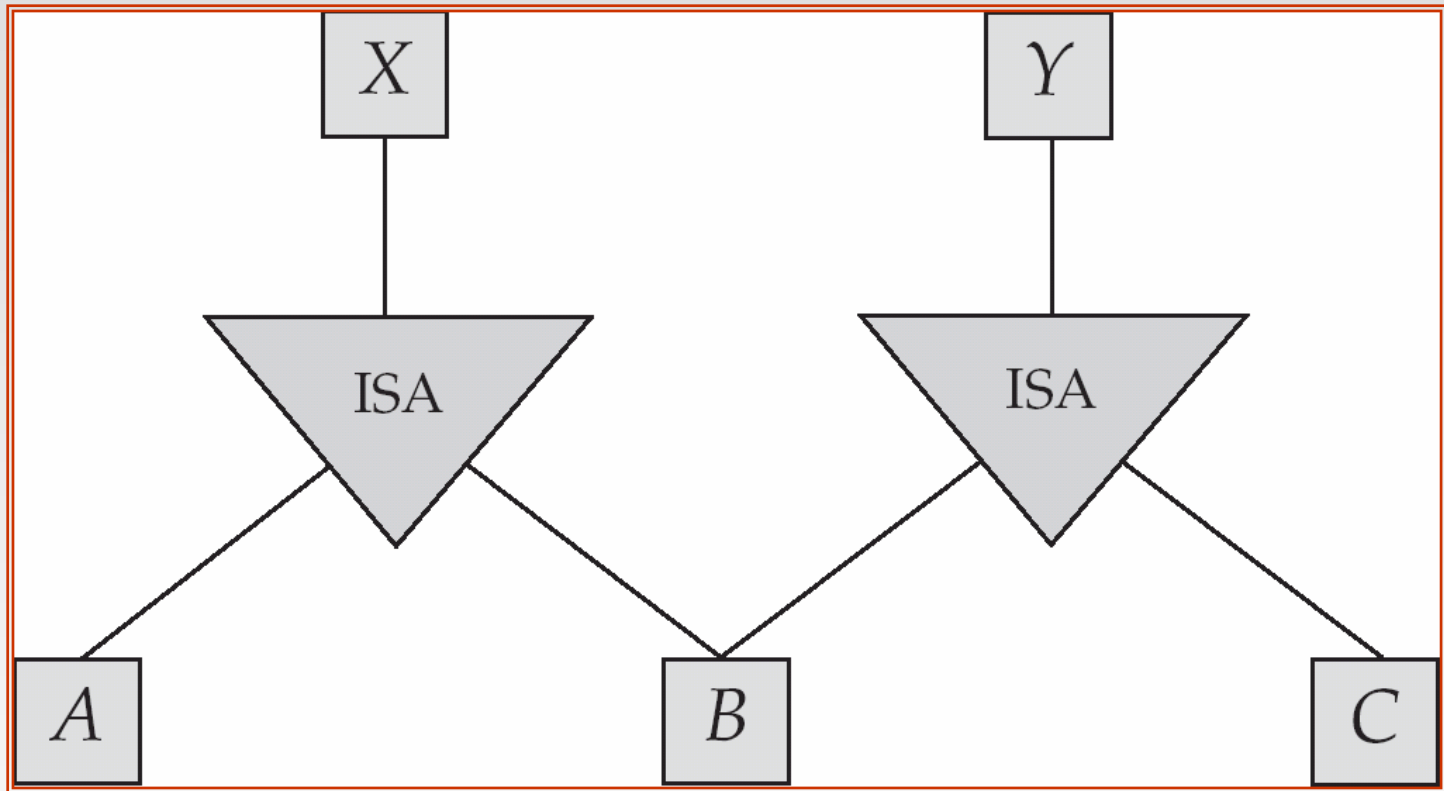





# Figure 6.31

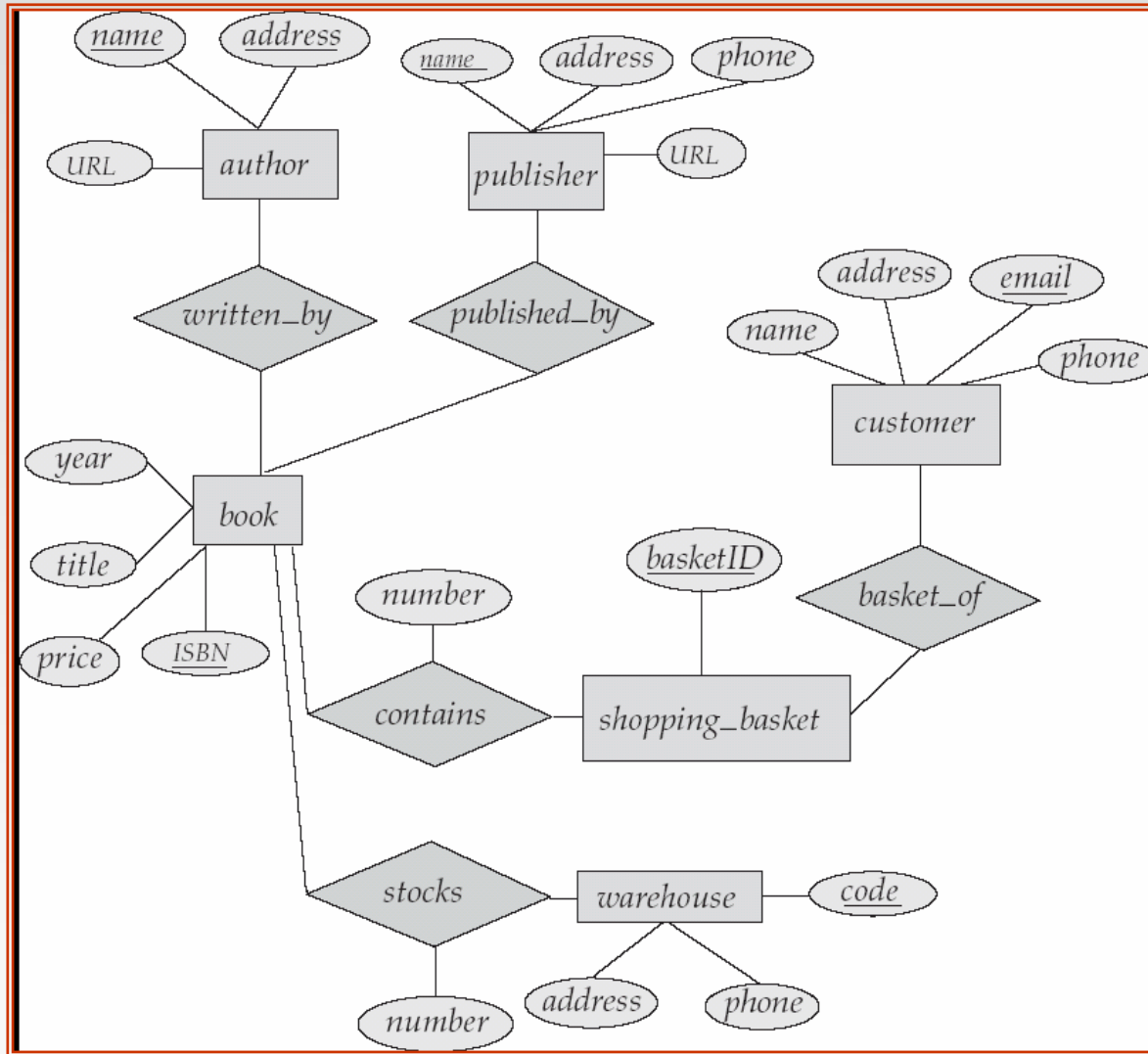



# Alternative E-R Notations

## Figure 6.24

